

Spectrum Brands

REMINGTON  Russell Hobbs

united
INDUSTRIES

 **VARTA**



Hardware &
Home Improvement

RAYOVAC

Presentation to

**Credit Suisse Under Followed
Opportunities Conference**

Boston – March 20, 2013

**Dave Prichard
Vice President, Investor Relations**

Forward-Looking Statements

Certain matters discussed in this presentation, with the exception of historical matters, may be forward-looking statements within the meaning of the Private Securities Litigation Reform Act of 1995. All statements, other than statements of historical facts, regarding our business strategy, future operations, financial condition, estimated revenues, projected costs, projected synergies, prospects, plans and objectives of management, as well as information concerning expected actions of third parties, are forward-looking statements. These statements are subject to a number of risks and uncertainties that could cause results to differ materially from those anticipated as of the date of this presentation. Important factors that could cause our actual results to differ materially from those expressed or implied herein include, without limitation: our ability to manage and otherwise comply with our covenants with respect to our significant outstanding indebtedness or maintain our credit ratings; changes and developments in external competitive market factors, such as introduction of new product features or technological developments; development of new competitors or competitive brands or competitive promotional activity or spending or industry consolidation; the cost and effect of unanticipated legal, tax or regulatory proceedings or new accounting policies, laws or regulations (including environmental, public health and consumer protection regulations); seasonality of our products and changes in consumer demand for the various types of products we offer resulting in the loss of, or a significant reduction in, sales to significant retail customers; our ability to develop and successfully introduce new products, protect our intellectual property and avoid infringing the intellectual property of third parties; public perception regarding the safety of our products, including the potential for environmental liabilities, product liability claims, litigation and other claims; unfavorable developments in the global credit markets; the impact of overall economic conditions, terrorist attacks, acts of war or other unrest in international markets on consumer spending; fluctuations in commodities prices, supply shortages, the costs or availability of raw materials or terms and conditions available from suppliers; changes in the general economic conditions in countries and regions where we do business, such as stock market prices, interest rates, currency exchange rates, inflation and consumer spending; our ability to successfully implement manufacturing, distribution and other cost efficiencies and to continue to benefit from our cost-cutting initiatives; the impact of expenses resulting from the implementation of new business strategies, divestitures or restructuring activities; our ability to integrate, and to realize synergies from, the combined businesses of Spectrum Brands, Inc. and Russell Hobbs, Inc.; our ability to identify, develop and retain key employees; unfavorable weather conditions or climate change and various other risks and uncertainties, including those discussed herein and those set forth in our filings with the Securities and Exchange Commission (“SEC”).

We also caution the reader that undue reliance should not be placed on any forward-looking statements, which speak only as of the date of this presentation. We undertake no duty or responsibility to update any of these forward-looking statements to reflect events or circumstances after the date of this presentation or to reflect actual outcomes. Additional factors that may affect future results and conditions are described in our filings with the SEC, which are available at the SEC’s web site at www.sec.gov or at Spectrum Brands’ website at www.spectrumbrands.com. The information contained in this presentation is summary information that is intended to be considered in the context of our SEC filings, and other public announcements that we may make, by press release or otherwise, from time to time. In addition, information related to past performance, while helpful as an evaluative tool, is not necessarily indicative of future results, the achievement of which cannot be assured. You should not view our past performance, or information about the market, as indicative of our future results. Further, performance information respecting investment returns on portfolio transactions is not directly equivalent to returns on an investment in our common stock.

Reconciliation of Non-GAAP Financial Measurements

Management believes that certain non-GAAP financial measures may be useful in certain instances to provide additional meaningful comparisons between current results and results in prior operating periods. Excluding the impact of current exchange rate fluctuations may provide additional meaningful reflection of underlying business trends. In addition, within this presentation, including the tables that follow, reference is made to adjusted earnings before interest, taxes, depreciation and amortization (EBITDA), free cash flow and adjusted gross profit.

Adjusted EBITDA is a metric used by management and frequently used by the financial community which provides insight into an organization's operating trends and facilitates comparisons between peer companies, because interest, taxes, depreciation and amortization can differ greatly between organizations as a result of differing capital structures and tax strategies. Adjusted EBITDA can also be a useful measure of a company's ability to service debt and is one of the measures used for determining the Company's debt covenant compliance. Adjusted EBITDA excludes certain items that are unusual in nature or not comparable from period to period.

In addition, the Spectrum Brands' management uses adjusted gross profit as one means of analyzing the Spectrum Brands' current and future financial performance and identifying trends in its financial condition and results of operations. Management believes that adjusted gross profit is a useful measure for providing further insight into Spectrum Brands' operating performance because it eliminates the effects of certain items that are not comparable from one period to the next.

Also, management believes that free cash flow is useful to both management and investors in their analysis of Spectrum Brands' ability to service and repay its debt and meet its working capital requirements. Free cash flow should not be considered in isolation or as a substitute for pretax income (loss), net income (loss), cash provided by (used in) operating activities or other statement of operations or cash flow statement data prepared in accordance with GAAP or as a measure of profitability or liquidity. In addition, the calculation of free cash flow does not reflect cash used to service debt and therefore, does not reflect funds available for investment or discretionary uses.

Spectrum Brands provides this information to investors to assist in comparisons of past, present and future operating results and to assist in highlighting the results of on-going operations. While Spectrum Brands' management believes that non-GAAP measurements are useful supplemental information, such adjusted results are not intended to replace the Spectrum Brands' GAAP financial results and should be read in conjunction with those GAAP results.

Attractive Segment Profile and Diverse Portfolio of Unrivaled Brands

Global Batteries & Appliances
FY2012 Net Sales \$2.25B;
EBITDA \$308M



Global Pet Supplies
FY2012 Net Sales \$616M;
EBITDA \$113M



Home and Garden
FY2012 Net Sales \$387M;
EBITDA \$87M



Hardware &
Home Improvement *



Spectrum Brands' portfolio includes widely used, non-discretionary, replacement consumer brands

Note: Segment adjusted EBITDA excludes \$22 million of corporate /unallocated expenses in fiscal 2012.

* Hardware & Home Improvement was acquired by Spectrum Brands on December 17, 2012 (the first quarter of fiscal 2013) .

Spectrum Brands – Providing Quality and Value to Retailers and Consumers Worldwide

- FY2012 net sales and adjusted EBITDA of \$3,252 million and \$485 million, respectively
- Spectrum Brands Value Model drives success of strong, well-recognized and extendable brand names
- Top 3 global market positions in all product categories
- Global footprint with presence on 6 continents and products sold in approximately 140 countries
- Strong relationships with major retailers globally
- Experienced and proven management team

Diverse Portfolio Across Attractive Categories

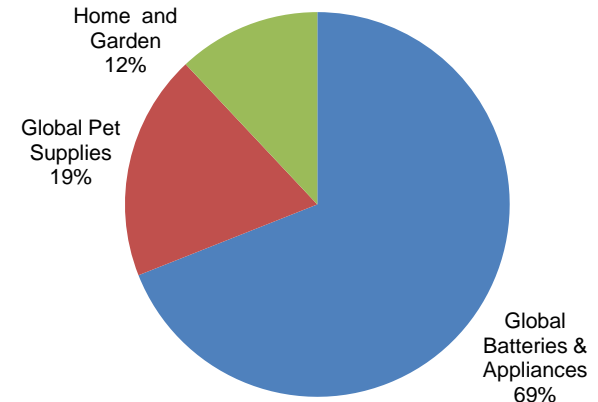

FY2012 Net Sales - \$3,252 million

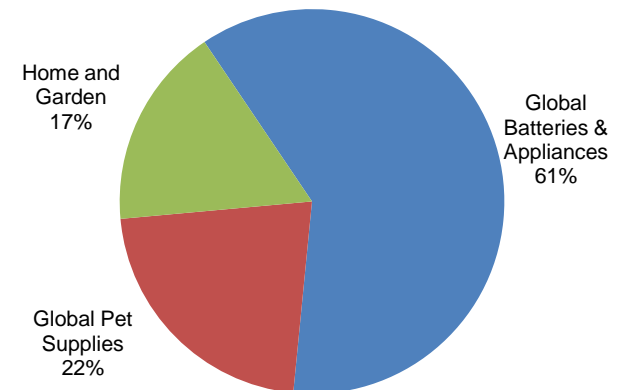

FY2012 Adjusted EBITDA - \$485 million^(a)

The “Spectrum Value Model” drives adjusted EBITDA growth

(a) Adjusted EBITDA includes \$22 million of corporate / unallocated expenses.

Strong Financial Performance Despite a Challenged Consumer

- Quarter-over-quarter net sales and adjusted EBITDA growth virtually without exception since FY2009
- Personal Care, Home and Garden and Pet Supplies have lead the adjusted EBITDA improvements
- Drivers of solid financial performance include:
 - Resilient demand for Spectrum Brands products across categories with “superior value” brand positioning
 - Increased distribution/market share in key product segments worldwide
 - Emphasis on continuous improvement , global new product development , efficient operating culture, and strong expense controls
 - Cost-saving initiatives at Spectrum Brands, Russell Hobbs and Global Pet from SKU/ brand rationalization and plant/distribution center consolidations
 - Leveraging infrastructure to lower production expense through facility closures/SAP
 - Focus on non-discretionary, non-premium priced, consumer replacement products
- CapEx focus on product development/cost reductions

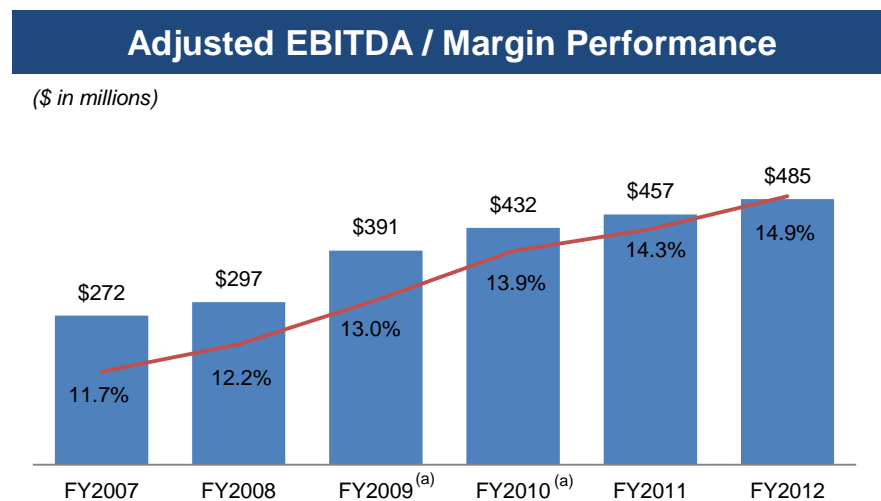
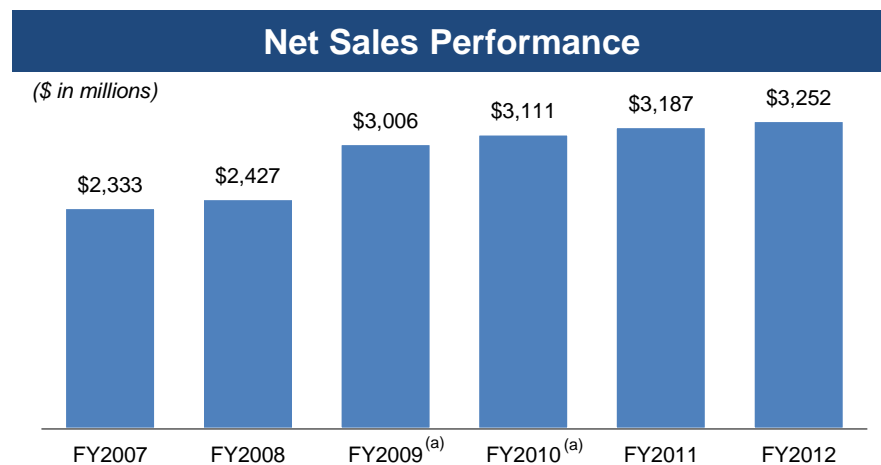

Spectrum Brands has generated robust sales and adjusted EBITDA growth, both organically and by acquisitions

(a) Reflects pro forma as if Russell Hobbs merger completed at beginning of respective period.

Record Performance – FY12 vs. FY11

Net Sales

(\$ in millions)

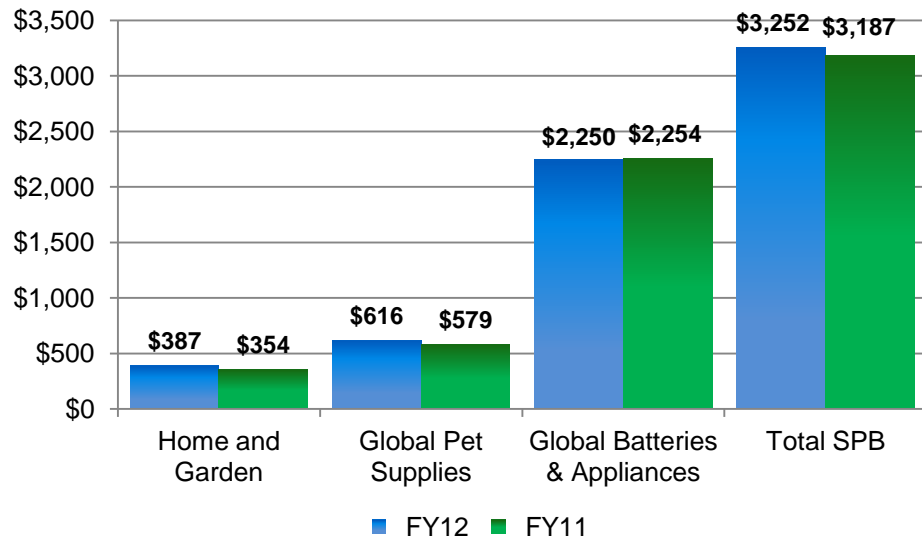

Adjusted EBITDA

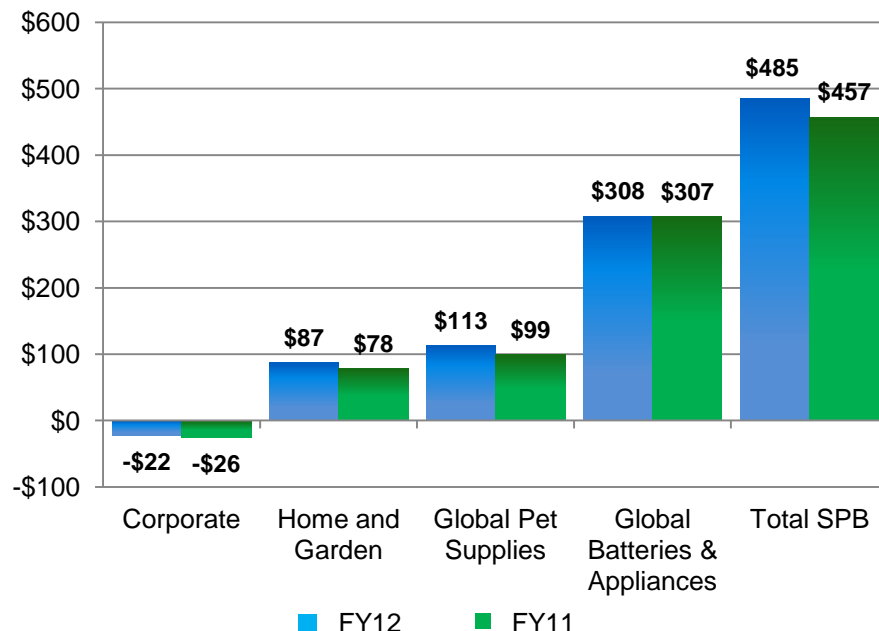

- Swung to net income of \$48.6 million and diluted EPS of \$0.91 vs. net loss of \$75.2 million and diluted loss per share of \$1.47, respectively
- Adjusted EPS of \$2.28 increased 25 percent, the third consecutive year of improvement
- Record net sales, operating income and adjusted EBITDA grew 2 percent, 32 percent and 6 percent, respectively
- Third consecutive year of record adjusted EBITDA
- Free cash flow of \$208 million exceeded guidance and \$191 million in FY11

Record Performance – Q1 FY13 vs. Q1 FY12

Net Sales

(\$ in millions)

Adjusted EBITDA

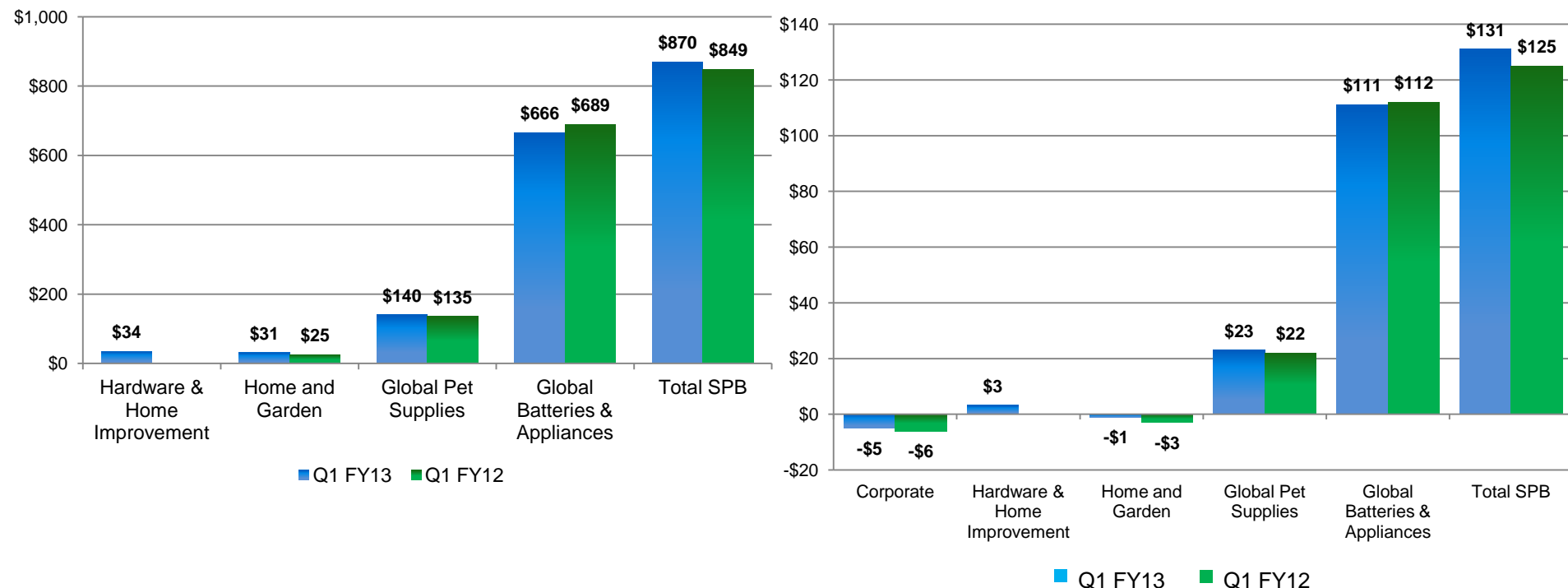

- Record net sales, including HHI and FURminator, increased 2.5 percent, or 3.2 percent excluding negative FX impact
- Adjusted EPS of \$0.72 increased 4.3 percent
- Adjusted EBITDA of \$131 million was 4th consecutive record first quarter level, and an increase of 4.5 percent vs. FY12

Spectrum Brands Vision

VISION

Be the leader in retailer metrics with superior value consumer products for everyday use

GOAL

Create shareholder value through adjusted EBITDA and free cash flow growth and debt reduction

Spectrum Value Model:

“Same Performance, Less Price / Better Value”

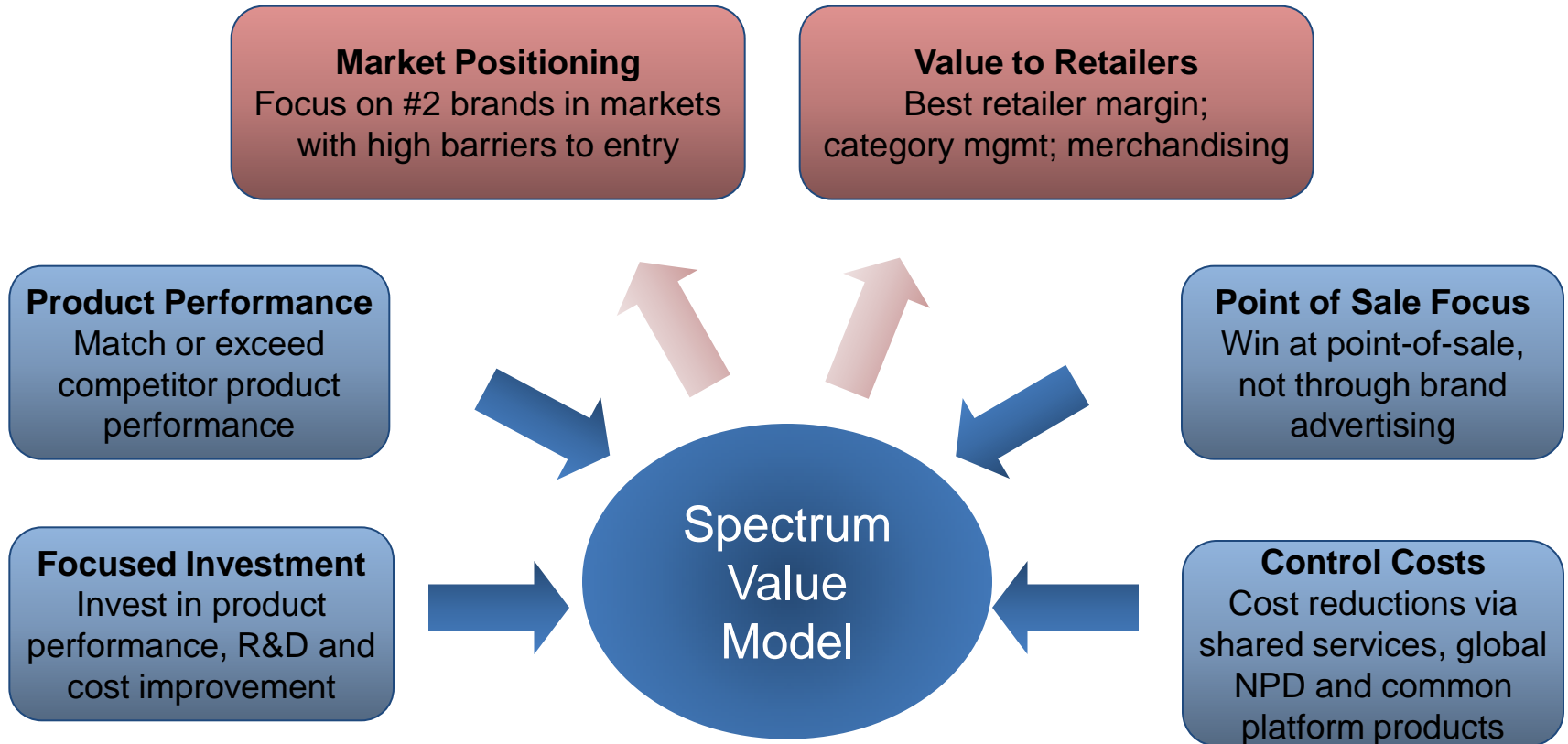

The “Spectrum Value Model” differentiates Spectrum Brands and helps provide stability and sustainable earnings

Leading Market Share and Competitive Brands

Category	Select Key Brands	Market Position
Consumer Batteries	 	#3 (North America) #2 (Europe) #1 (Latin America)
Electric shaving and grooming	REMINGTON 	#2 (North America, UK, Australia) #2 / #3 (Continental Europe)
Electrical personal care products	REMINGTON 	#1 (Australia) #2 (Europe) #3 (North America)
Portable lighting	 	#2 (North America, Europe, Latin America)
Kitchen & home products	   	#2 (U.S. kitchen products) #1 (U.S. hand-held irons) #1 (UK kitchen/home products)
Pet supplies	    	#2 (Global pet supplies) #1 (Global aquatics)
Home & garden control products	    	#2 (U.S.)
Residential locksets	Kwikset WEISER BALDWIN	#1 in U.S. locksets #1 in Canada locksets #1 in U.S. luxury locksets
Builders' hardware	   BALDWIN	#1 in U.S. builders' hardware #2 in Mexico hardware
Faucets	Pfister	#4 / #3 in U.S. retail channel

Note: All market size and market position information is per Company estimates and industry data.

Successful Track Record of Acquisition Integration/Deleveraging

- Track record of using strong free cash flow generation to reduce debt
- Proven integrator – successfully integrated Russell Hobbs, exceeding synergy goals, as well as more recent add-ons FURminator® and Black Flag®/TAT®
- Significant NOLs and limited CapEx requirements enhance free cash flow profile
- \$370 million of Term Loan debt prepayment since beginning of FY2011, helping to reduce interest expense
- Opportunistic approach to debt refinancing to ensure lowest possible rates on all debt tranches
- Strong free cash flow will enable Spectrum Brands to deleverage balance sheet toward long-term total leverage ratio target of 2.5x - 3.5x in approximately two years following HHI acquisition at year-end 2012

Total leverage^(a)

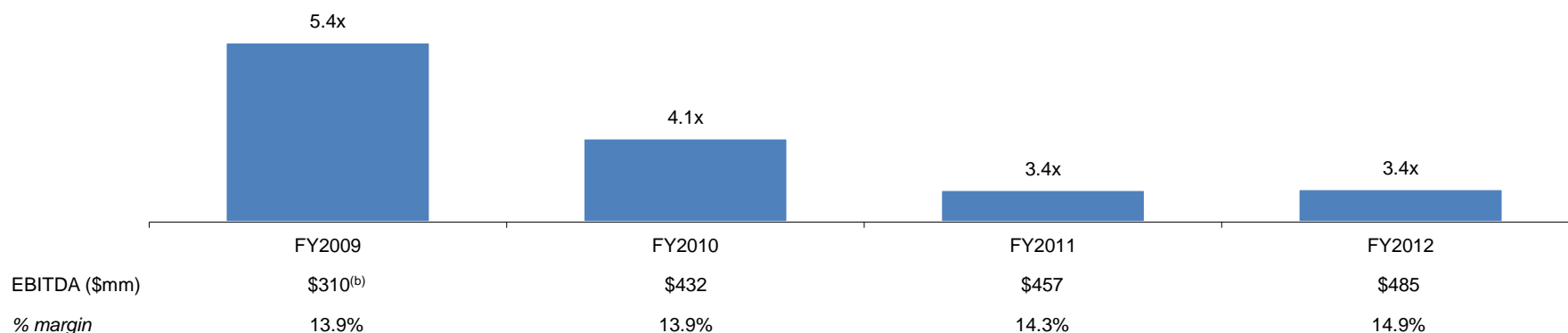

Spectrum Brands' strong FCF and commitment to reduce debt have provided enhanced shareholder value

(a) Calculated as total gross debt / adjusted EBITDA. Gross debt is stated prior to OID and other discounts.

(b) Standalone adjusted EBITDA of \$310 million, pro forma for Russell Hobbs adjusted EBITDA is \$391 million.

Growth Strategies –

Pursue Select Bolt-On Acquisitions to Further Enhance Scale

Key acquisition priorities

Global Pet Supplies

- Large and rich list of targets identified for bolt-on acquisitions
- Primary focus in Companion Animal (e.g., FURminator®)
- Potential acquisition categories include dog and cat treats, dog and cat healthcare, wild bird, dog and cat nutrition, reptile, and pet training and containment
- Seek targets that offer manufacturing and/or distribution synergies
- Fragmented industry is ripe for consolidation

Home and Garden

- Targets focused on small to medium-sized CPG companies in the H&G and cleaning categories
- Seek targets that offer product strategic fit and/or manufacturing and distribution synergies (e.g., Black Flag®/TAT® brand assets)
- Complementary brands and categories
- Evaluating liquid and aerosol fill opportunities

Spectrum Brands continually evaluates synergistic, bolt-on acquisitions to expand its product line, extend market penetration and grow its geographic footprint

Global Batteries & Appliances (GBA) Segment

REMINGTON®

 Toastmaster®

GEORGE FOREMAN®
HEALTHY COOKING

 **VARTA**

RAYOVAC®

Juiceman®

Breadman®

FARBERWARE®

 **BLACK & DECKER®** Home



**Russell
Hobbs**

**Global Batteries
& Appliances**



Global Batteries & Appliances Segment (GBA)

- Operating results driven by Spectrum Value Model
 - Same quality/performance at a lower price
 - Global battery business is growing market share/fastest growth in U.S.
 - Battery industry is stable and expected to continue modest annual growth in cell units
 - Device population has stabilized and resumed growth
 - Appliances business holds market-leading positions in 6 key categories
- Consumers are switching to value brands
 - Experiencing market share gains in many categories around the world
- Large customers gaining share of total market, helping propel our share gains
 - Driving foot traffic into big-box retailers
 - Renewed focus on “one-stop shopping”
- Company is capitalizing on its platform with innovation and new product launches (e.g., women’s hair care accessories, i-LIGHT Pro™)
- Strong adjusted EBITDA growth despite soft economy, rising costs from Asian suppliers and volatile FX
- Battery businesses better by \$13 million FX adjusted in FY12; Appliances \$7 million of FX

Adjusted EBITDA Performance - GBA

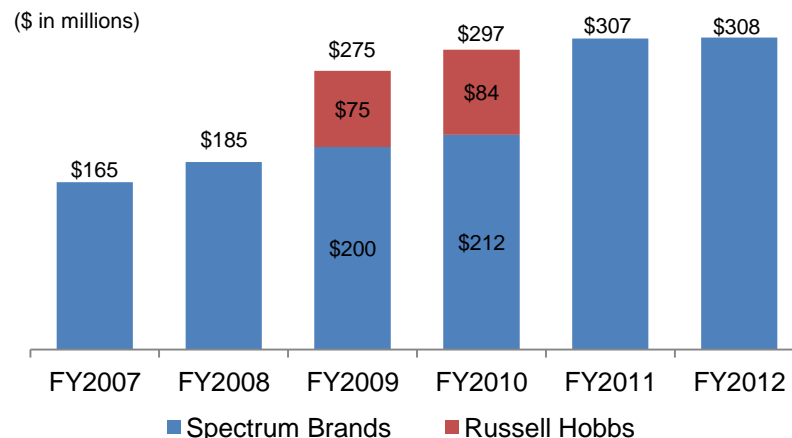

Rayovac Alkaline continues double-digit dollar and unit sales growth while the category has softened in recent periods.

Dollar Sales % Change YAG

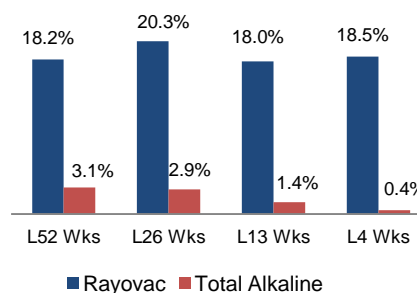

Unit Sales % Change YAG

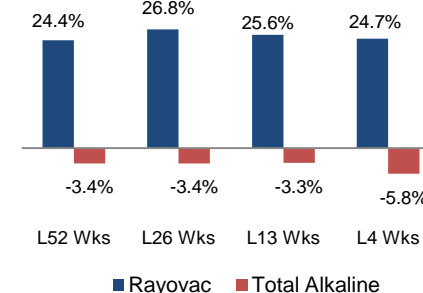

Note: Total U.S. Expanded All Outlets Combined (XAOC) includes: Food, Drug, Mass, Walmart, Sam's, BJ's, dollar stores (excluding Dollar Tree) and DeCA. Other portions of the Battery market, including channels such as DIY (e.g., Home Depot and Lowe's), are excluded.

Source: Nielsen Total U.S. XAOC, periods ended February 2, 2013

Global Appliances Industry with a Large Footprint

- Stable, recession-resistant
 - Replacement nature/everyday use products
- Strong portfolio of flagship brands
 - Remington, Black & Decker, George Foreman, Russell Hobbs, Farberware
 - Leading market positions in served categories
- Global Appliances has the number 4 position in the global small appliance rankings, overtaking both Conair and Jarden

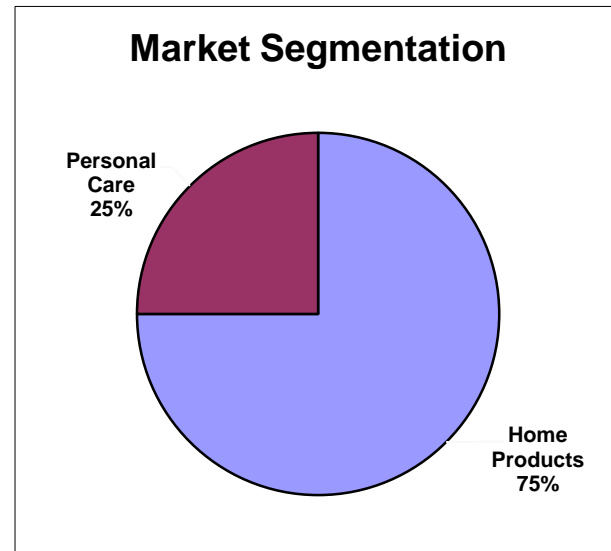
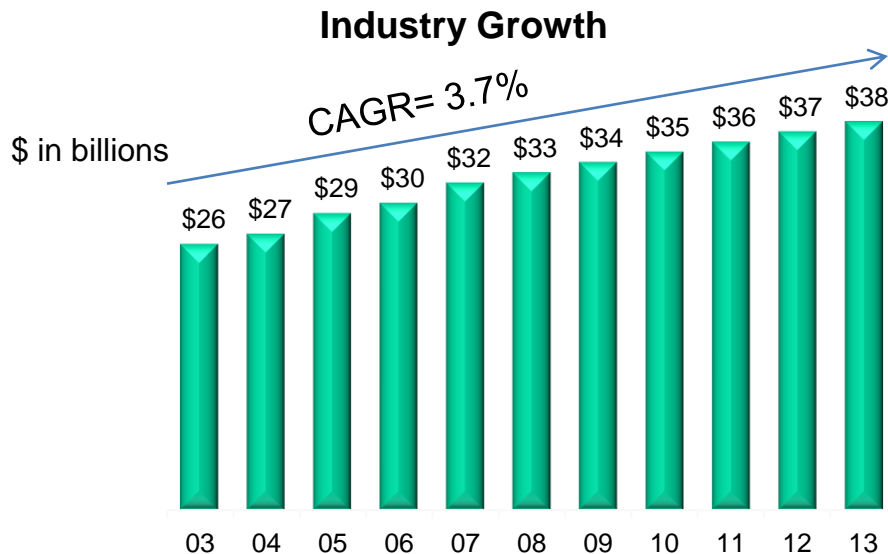

Source: Euromonitor - GA Addressed

Worldwide market share position: Phillips 5.9%, Groupe SEB 5.2%, P&G 5.1%, SPB 4.1%, Conair 3.5% and Jarden 3.5%

Hardware & Home Improvement Segment (HHI)

Kwikset

BALDWIN[®]

WEISER

Pfister[™]

STANLEY[®]

**National
Hardware**[™]

FANAL[®]

EZSET[®]



HHI Overview

Business Description

- HHI is a leading provider of residential locksets, builders' hardware, and faucets
 - #1 U.S. lockset and #1 Canadian lockset, #1 U.S. luxury hardware, #1 U.S. builders' hardware, # 4 U.S. faucets
 - Largest global tubular lock manufacturer (~50 million units/year)
- Diversified product portfolio with well-recognized brands, characterized by outstanding new product innovation and execution
- Large install base, ~900 million locks/66 million households
- Long-standing and highly collaborative relationships with customers across all channels
- In process of acquiring certain residential assets of Tong Lung, a Taiwan-based private label lock manufacturer and historically a key supplier to HHI

Product Overview

Residential Locksets









Builders' Hardware



Faucets









Recognized and Established Brands

	Residential Locksets			Builders' Hardware		Plumbing
Brand	Kwikset	WEISER	BALDWIN	STANLEY National Hardware™	FANAL	Pfister
Established	1946	1904	1946	1843 / 1901	1947	1910
Market Position	#1 in U.S. Locksets	#1 in Canada Locksets	#1 in U.S. Luxury Locksets	#1 in U.S. Builders' Hardware	#2 in Mexico Hardware	#4 U.S. in Faucets (#3 in U.S. Retail Channel)
Key Products						
Features	Style, Finish, Innovation, Security, Affordable	Architecturally Influenced Style, Finish, Security, Innovation	Luxury and Quality Leader, Solid Construction, Broad Styles, Functions and Finishes	Broadest Offering, Durable and Consumer Friendly, Superior Sales Replenishment Service Model	Broad Offering, Durable, Security, Affordable	Industry-leading Designs and Styles, Affordable

HHI Enjoys Excellent Customer Relationships

Dedicated national sales force with robust customer relationships across all distribution channels

Customer	Description of Relationship	Value Proposition
 	<ul style="list-style-type: none"> ▪ Won Home Depot Vendor of the Year in 2011 ▪ Supply chain and fill rate management ▪ Mix management and merchandising ▪ In-store support and training ▪ Wins during recent line reviews 	<ul style="list-style-type: none"> ▪ Install base ▪ Brand strength ▪ Relevant and valued technology ▪ Cost competitive ▪ Category management ▪ Strong OPEX
 	<ul style="list-style-type: none"> ▪ Co-op affiliated independent hardware stores ▪ Supply chain and fill rate management ▪ Manage hardware shelf stock inventory and replenishment orders with industry-leading direct sales force 	<ul style="list-style-type: none"> ▪ Breadth of offering ▪ Direct sales ▪ Automated fulfillment model
   	<ul style="list-style-type: none"> ▪ Regional and large builder account management and selling ▪ Contractual agreements with large accounts ▪ Continuing to gain market share ▪ Primary supplier to top U.S. home builders for several decades 	<ul style="list-style-type: none"> ▪ Brand strength ▪ Style and finish breadth ▪ Technology ▪ Cost competitive ▪ Tiered upgrade options

HHI Brings Excellent Global Growth Opportunities and Entry Into the Residential and Light Commercial Businesses

- HHI has a diversified existing product portfolio that is complemented by outstanding new product innovation and execution
- Opportunity to grow market share in the mechanical security market globally

HHI's Three Segments

Segment	Products	Highlights
Residential locksets		<ul style="list-style-type: none"> ▪ Industry-leading functional and style innovation and attractive price point ▪ Expanded sales and lock platform capabilities available through Tong Lung acquisition, allowing for accelerated expansion in international markets
Builders' hardware		<ul style="list-style-type: none"> ▪ High volume order fulfillment capability and supply chain management ▪ Well positioned to benefit from trends in home automation and a recovery in the residential construction market
Faucets		<ul style="list-style-type: none"> ▪ \$200 million business within attractive \$12.2 billion global market ▪ Trusted brand and products, that deliver a remarkable customer experience: style, innovation, at competitive price points

SmartKey is One of HHI's Most Successful Innovations: Game Changing, Disruptive Technology that Continues to Expand

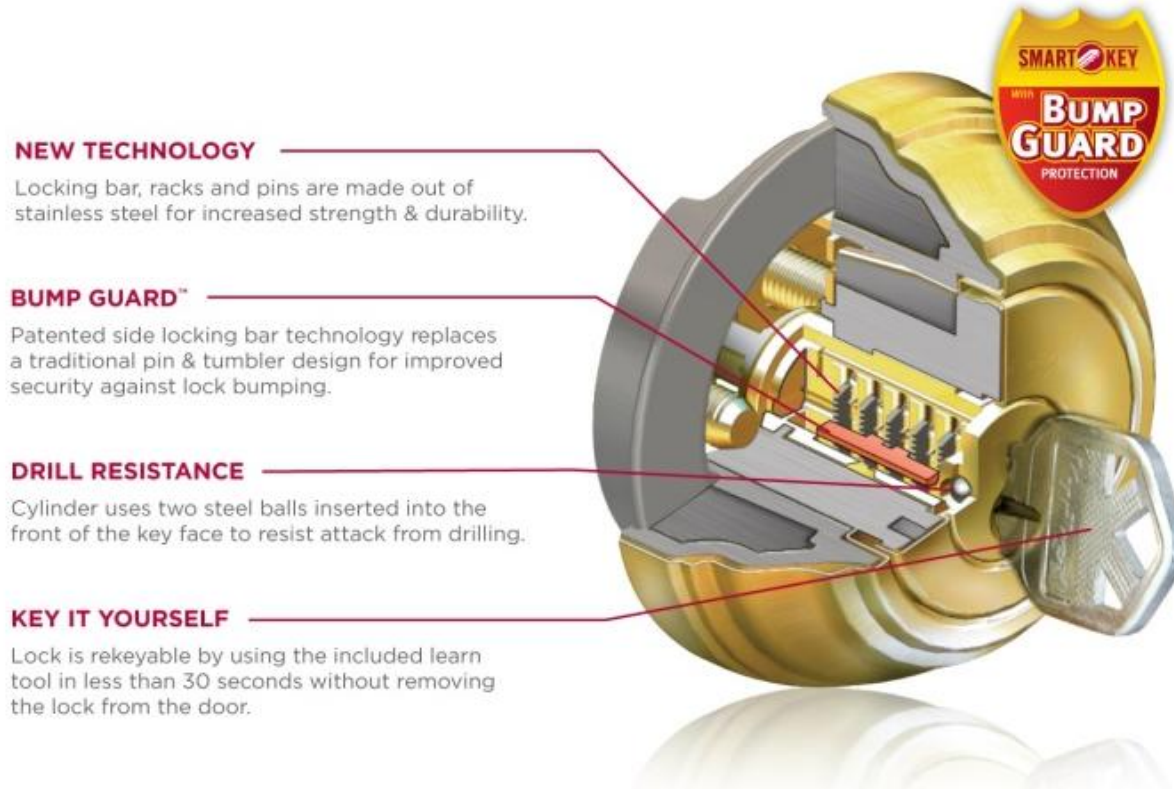

HHI Acquisition Significantly Increases Spectrum Brands' Scale

Combined Company

- The acquisition adds an established, growing and profitable hardware and home products business dedicated to innovative product design and technology
- HHI adds approximately \$1 billion of sales, and almost \$200 million of incremental adjusted EBITDA to Spectrum Brands' existing business
- The acquisition adds another platform for global growth using Spectrum Brands' existing international infrastructure

Financial Scale – FY2012^(a)

(\$ in millions)

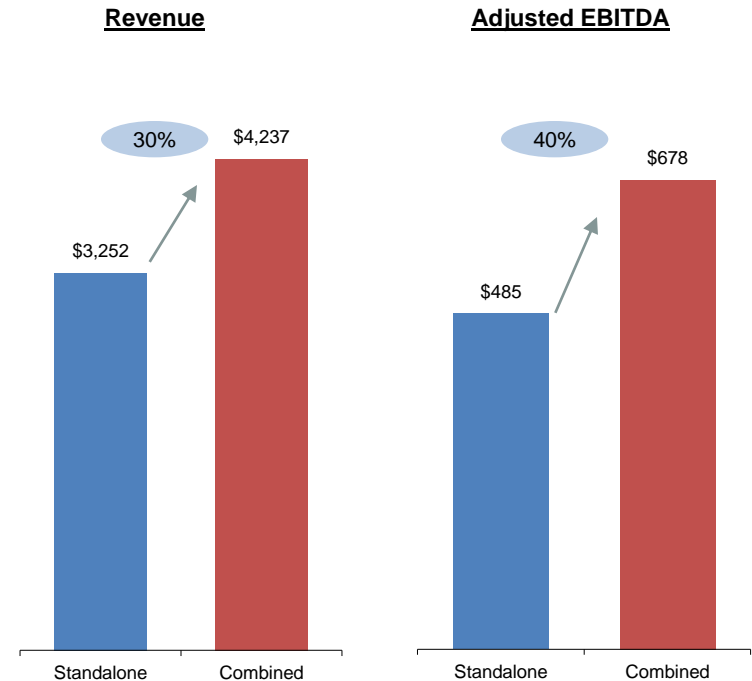

(a) FY2012 Revenue based on FY2012 Spectrum Brands revenue of \$3,252 million and LTM 6/30/12 HHI revenue (\$939 million HHI and \$46 million Tong Lung). FY2012 Adjusted EBITDA based on FY2012 Spectrum Brands Adjusted EBITDA of \$485 million, LTM 6/30/12 HHI Adjusted EBITDA (\$181 million HHI and \$7 million Tong Lung) and \$5 million in synergies. Tong Lung figures as of LTM 12/31/11.

Robust Combined Business with Solid Free Cash Flow Profile and Enhanced Margins

- HHI acquisition immediately increases Spectrum Brands' margins to 16% with further expansion expected
- Adds \$90 million in incremental free cash flow in first two years and also accelerates Spectrum Brands' ability to recognize benefits from existing NOLs

FY2012 Combined Adjusted EBITDA – CapEx^(a)

(\$ in millions)

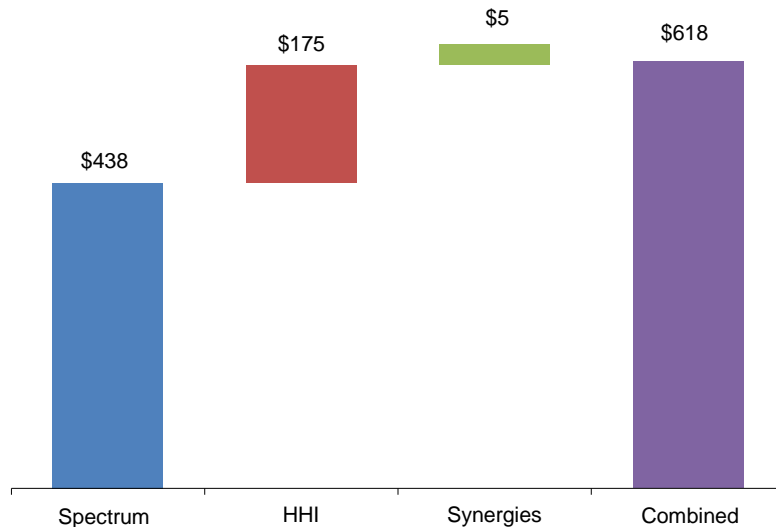

FY2012 Adjusted EBITDA Margin

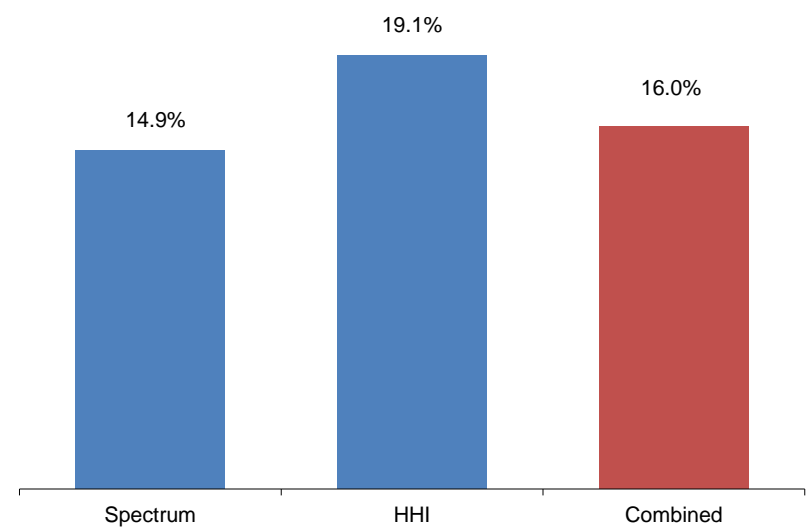

Note: Spectrum Brands as of FY2012, HHI as of LTM 6/30/12 including Tong Lung as of LTM 12/31/2011.

(a) FY2012 capex of \$47 million for Spectrum Brands and LTM 6/30/12 capex of \$13 million for HHI.

Global Pet Supplies Segment



UNITED WE STAND,
 We stand for better health, better play, longer naps and more treats. A higher standard for pets of all kinds. UPG is committed to bring real solutions to pet owners and to make pets happy.

Attractive Global Pet Industry

- Global pet food/supplies industry estimated at \$72 billion in 2011
- Consistent annual growth of 3-4%
- UPG addresses a \$20.5 billion market segment with attractive growth characteristics, high fragmentation, and low seasonality

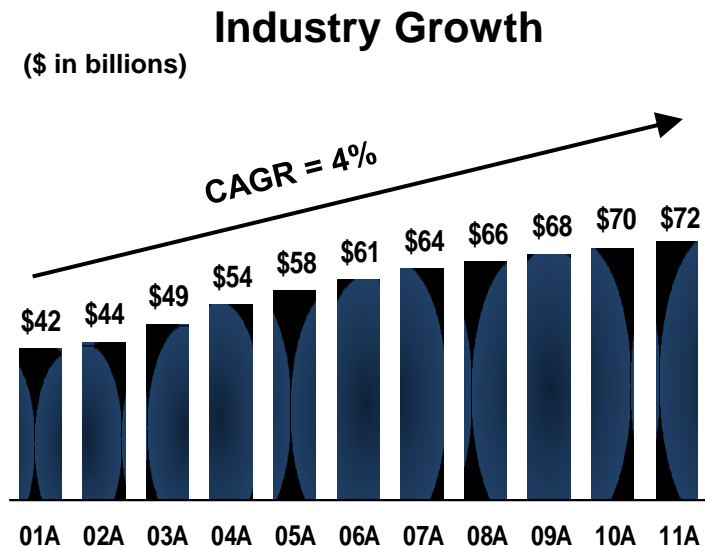

Market Segmentation

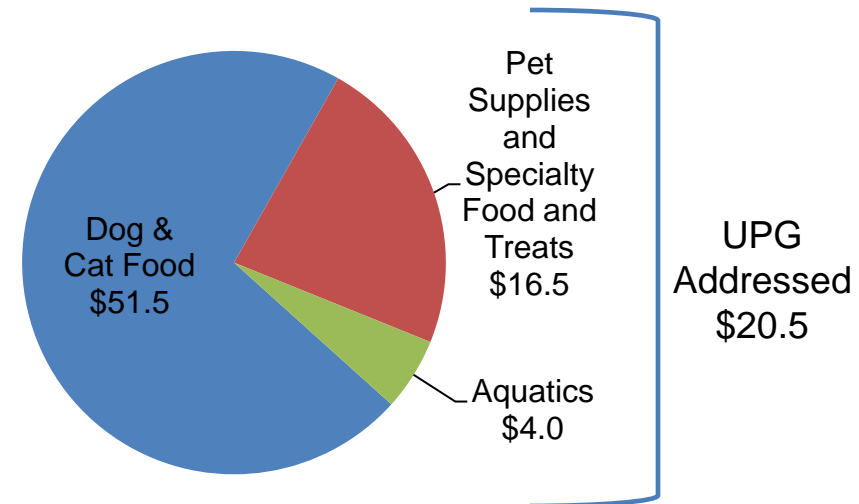

Source: Euromonitor and Management estimates

Global Pet Supplies Segment

Sole Player with Global Platform and Presence

Adjusted EBITDA Performance

(\$ in millions)

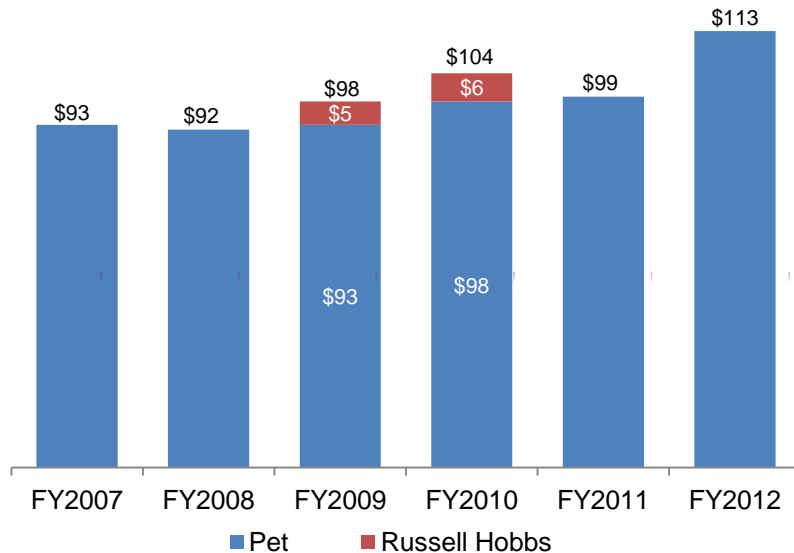

- Another record year expected in FY13
- Attractive industry trends (e.g., increasing pet ownership / spending per pet, low seasonality)
- North American aquatics business showing continued improvement / positive POS.
- Strong new product pipeline in FY12-13 in both aquatics and companion animals
- \$10-\$15 million of cost-cutting opportunities achieved in FY11-12
- Seeking acquisitive, “tuck-in” growth opportunities in companion animals (e.g., FURminator)

Net Sales by Category

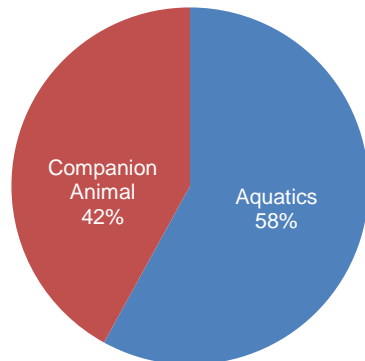

Net Sales by Geography

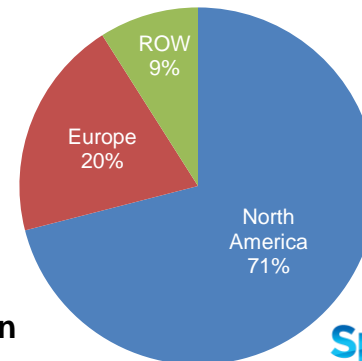

FY12 net sales: \$616 million

Home and Garden Segment (United Industries)

Industry-Leading Value Brands



Strong #2 Share in the Industry

U.S. Retail Home and Garden Pest Control Market

\$2.9 Billion Retail Category

Vendor Market Share Estimate

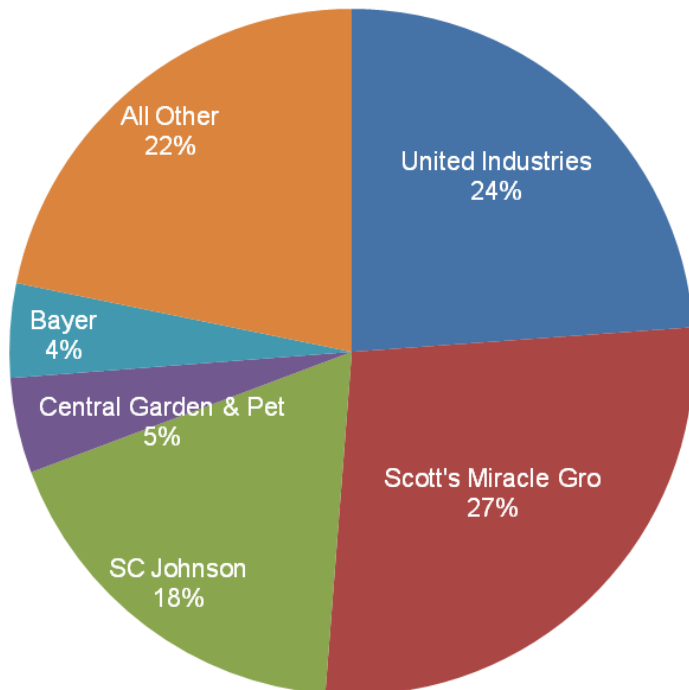

United Industries Share

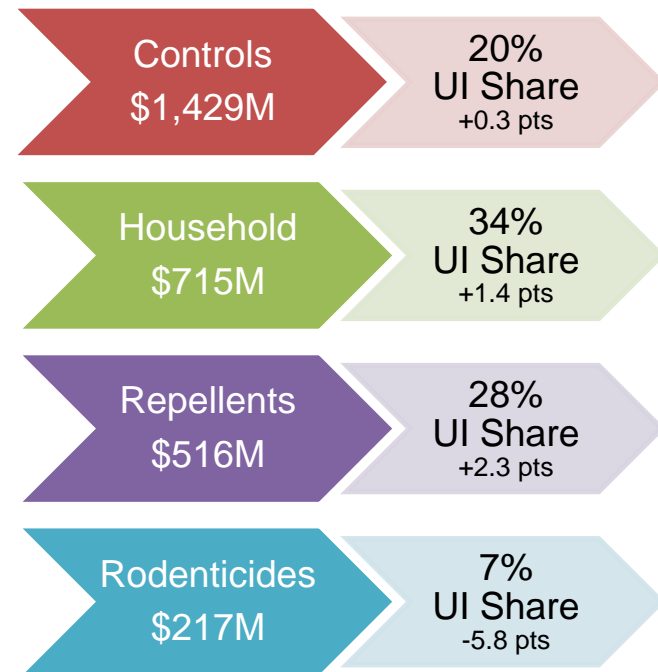

Market Change = +6.6% from 2011 to 2012

Source: United Industries Management Estimates

Note: Changes from past estimates due to Nielsen enhancements – WalMart POS and projection methodology improvements

Home and Garden Segment Delivering Robust Growth

Adjusted EBITDA Performance^(a)

(\$ in millions)

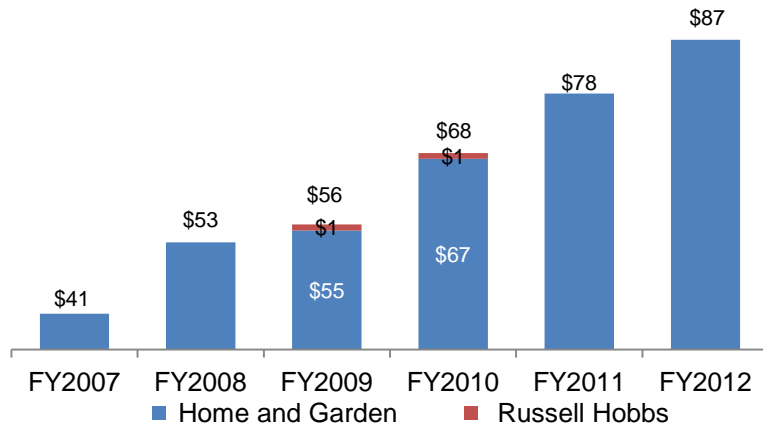

(a) Adj. EBITDA excludes impact of Growing Products division (shut down in Q2 FY09).

Home and Garden

- Another record year expected in FY13
- Strong financial results
 - Attractive margins
 - Low CapEx requirements
- Attractive industry trends
 - Outdoor living explosion
 - Strong underlying demographic patterns
- Unique competitive environment
 - Few large competitors
 - High entrance barriers
- Solid retail relationships
 - Retail sales team
 - Customer-focused platform sales teams
- Strong operations platform
 - Innovative R&D
 - Low-cost product provider

Drivers of Success

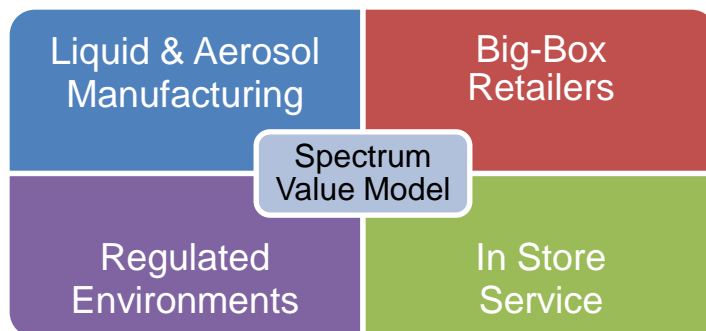

Committed to value model of providing same performance at less price

Spectrum Brands



Quarterly Dividend Initiated; One-Time Special Dividend Paid

- First quarterly common stock dividend of \$0.25 per share to be paid on March 12, 2013
 - Future 2013 quarterly dividends expected to be paid in June, September and December
- One-time, special dividend of \$1.00 per share paid on September 18, 2012 to shareholders of record on August 27
- Initiation of dividend recognizes strong, consistent free cash flow generation capability and commitment to deliver attractive returns to shareholders
- After fiscal 2013, opportunity to raise dividend will be evaluated based upon free cash growth
- Special dividend recognized strong fiscal 2012 results and allowed shareholders to receive a dividend in fiscal 2012 equivalent to our planned dividend in fiscal 2013
- In future years, payment of special dividend is not anticipated and should not be expected

Fiscal 2013 Outlook (including HHI)

- Legacy Spectrum Brands (excluding HHI) expected to achieve 4th consecutive year of record financial results, with improvements weighted to second half of FY13
- Net sales increase at or above rate of GDP
- Accretive HHI acquisition will provide significant, additional net sales, earnings per share, adjusted EBITDA and free cash flow to FY13 results and beyond
- Free cash flow, net of HHI acquisition costs, expected to be approximately \$240 million, or nearly \$5 per share
- CapEx of approximately \$70-\$80 million – predominantly for cost reduction and new product development
- Debt reduction of approximately \$200 million expected in second half of FY13 to lower total leverage to about 4.4x or less by year-end

Spectrum Brands

REMINGTON  Russell Hobbs

united
INDUSTRIES

 **VARTA**



Hardware &
Home Improvement

RAYOVAC

NYSE: SPB

www.spectrumbrands.com

investorrelations@spectrumbrands.com

Spectrum Brands

REMINGTON  Russell Hobbs

united
INDUSTRIES

 **VARTA**



Hardware &
Home Improvement

RAYOVAC.

Appendix

Experienced and Proven Management Team

Spectrum Brands Management		
Name / Position	Years with Company	Background
David R. Lumley CEO & President	6	<ul style="list-style-type: none"> CEO since April 2010 Served as Co-COO and President, Global Batteries, Personal Care and Home and Garden segments since January 2007 Previously served as President, North America since January 2006 Previously was President, Rubbermaid Home Products North America
Anthony L. Genito Executive Vice President & Chief Financial Officer	8	<ul style="list-style-type: none"> Joined Company in June 2004 and has held current position since June 2007 Previously spent 12 years with Schering-Plough in various financial management positions including CFO of International Pharmaceuticals and Global Supply Chain divisions and Corporate Assistant Controller Prior to joining Schering-Plough spent 12 years with Deloitte & Touche in the Accounting and Audit function
John A. Heil * President, Global Pet Supplies	12	<ul style="list-style-type: none"> Held position of President, Global Pet, since October 2005 Has led United Pet Group since June 2000 Previously spent 25 years with the H.J. Heinz Company in various executive management positions including President and Managing Director of Heinz Pet Products, President of Heinz Specialty Pet and Executive Vice President of StarKist Seafood
Terry L. Polistina President, Global Appliances	12	<ul style="list-style-type: none"> Has led Global Appliances since 2011 President and CEO of Russell Hobbs from December 2007 until merger with Spectrum in 2010 Previously spent 18 years with Appliance in various management positions, including COO from May 2006 to December 2007 and CFO from January 2001 to December 2007
Greg Gluchowski President, HHI	10	<ul style="list-style-type: none"> President of HHI since January 2010 Previously led Black & Decker's Global Operations for six years Led the early integration of the HHI division into the newly formed Stanley Black & Decker Corporation in 2010 Prior to joining Black & Decker in 2002 he served as Sr. Vice President-Customer Satisfaction, Vice President Global Operations, Vice President of Manufacturing for a division of Phelps Dodge Corporation

* Retires March 31, 2013

HHI Group Formation

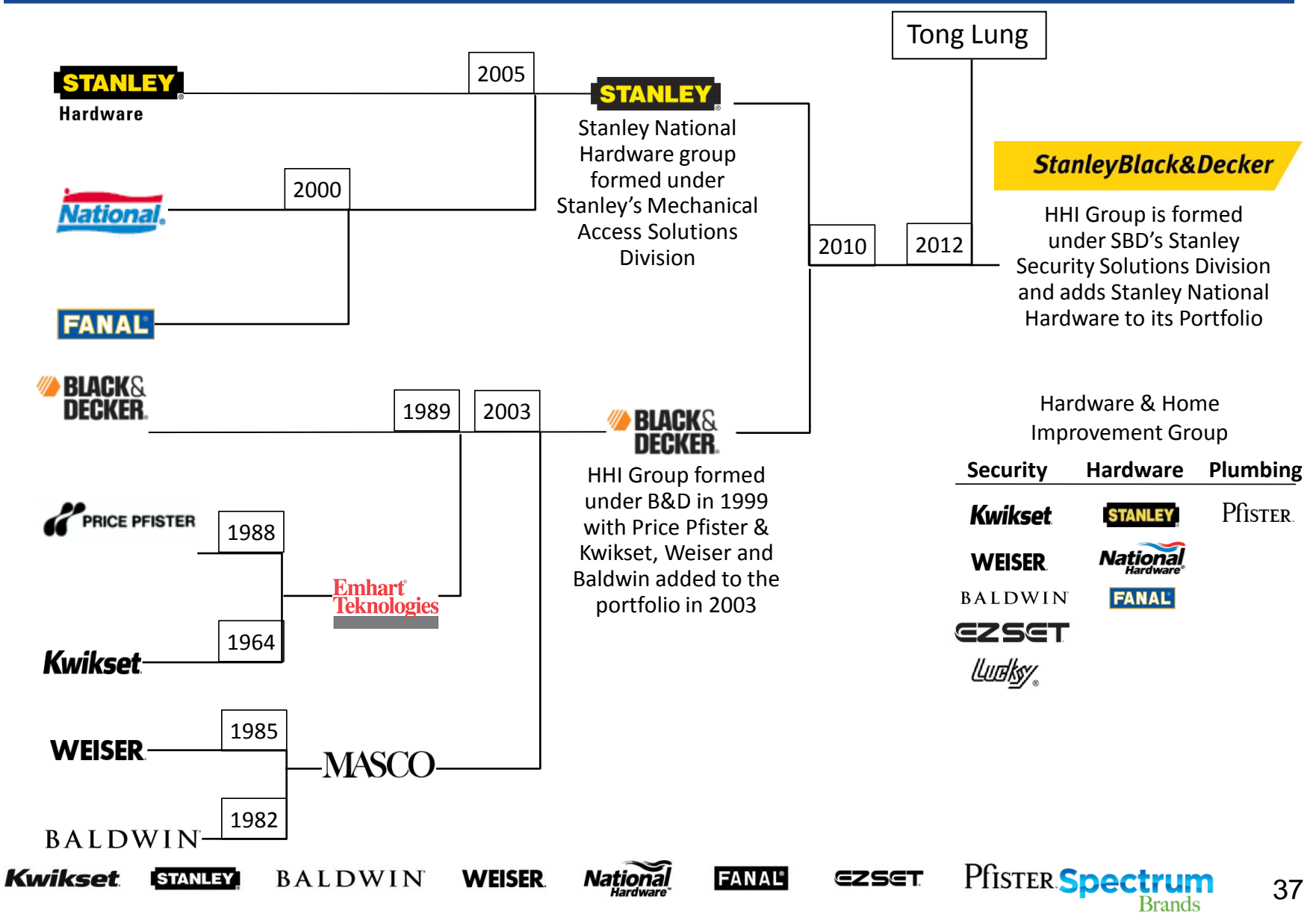

HHI Group Overview

Kwikset	WEISER	BALDWIN	STANLEY Hardware	National Hardware	FANAL	Pfister
Est. 1946	Est. 1904	Est. 1946	Est. 1843	Est. 1901	Est. 1947	Est. 1910

Revenue by Segment (LTM 6/30)

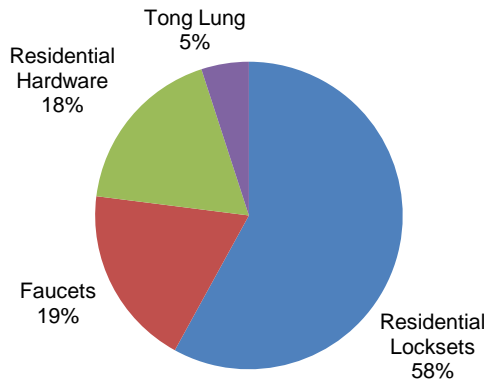

Financial Highlights (LTM 6/30)

Net Sales: \$985 million

Adjusted EBITDA: \$188 million

Adjusted EBITDA Margin: 19.1%

Revenue by Geography (LTM 6/30)

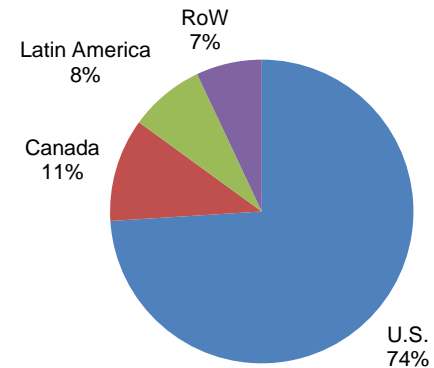

Note: Results based on LTM 6/30/12 for HHI. Tong Lung figures as of LTM 12/31/11.

Leading Market Position

HHI Market Shares

U.S. Residential Lockset Market

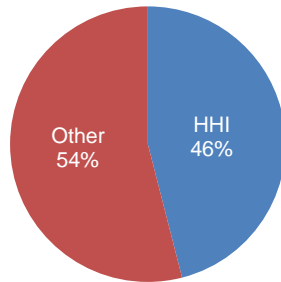

Canada Residential Lockset Market

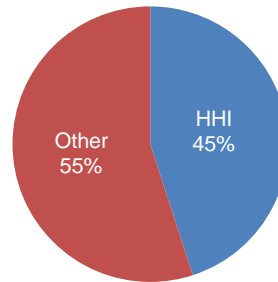

U.S. Builders Hardware Market

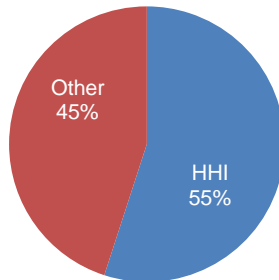

U.S. Luxury Lockset Market

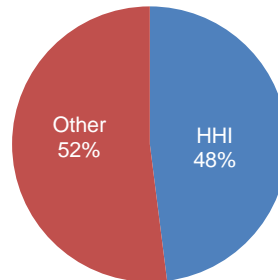

- Largest tubular lock manufacturer globally
- #1 U.S. lockset
- #1 Canadian lockset
- #1 U.S. luxury hardware
- #1 U.S. builders' hardware
- #4 U.S. faucets

Large scale and excellent channel management leading to #1 position with major retailers and top home builders

Strong Distribution and Channel Penetration



Installed base, strong product and brand presence drives pull through demand in all channels

HHI Acquisition Improves Customer Mix and Provides Deeper Penetration in Key Home Center Accounts

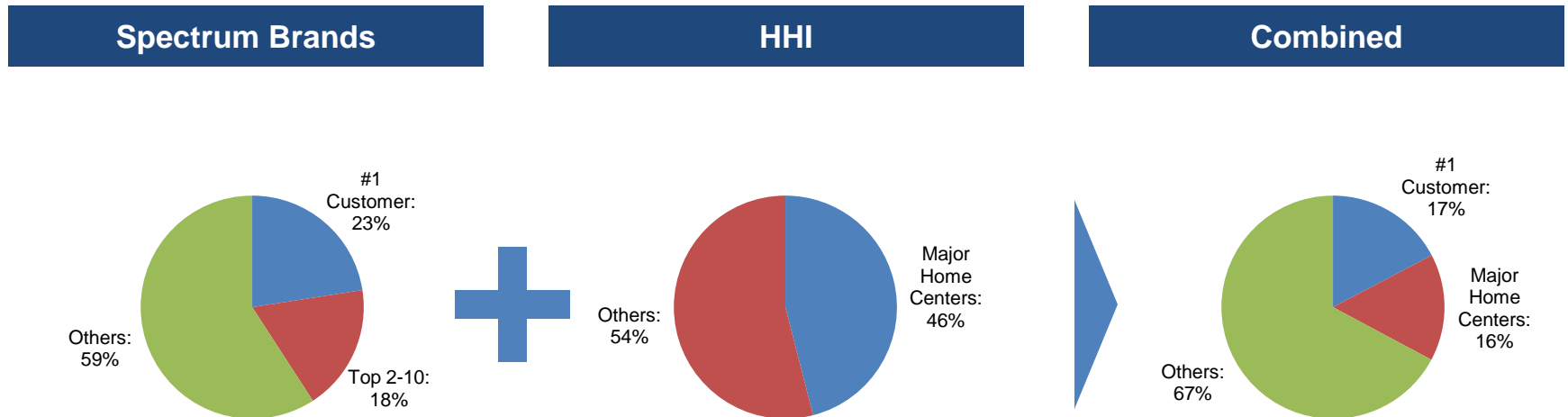

- The addition of HHI expands Spectrum Brands' relationships with major retailers such as home center customers
- Reduces reliance on #1 customer

Note: Figures based on FY2012 revenues for Spectrum Brands and FY2011 revenues for HHI.

HHI Can Grow Internationally by Leveraging Spectrum Brands' Global Infrastructure and Business Model

- Revenue opportunities to cross-sell each others' products
 - Utilize one company's particular strengths (brand awareness, distribution capabilities) to market the others' products

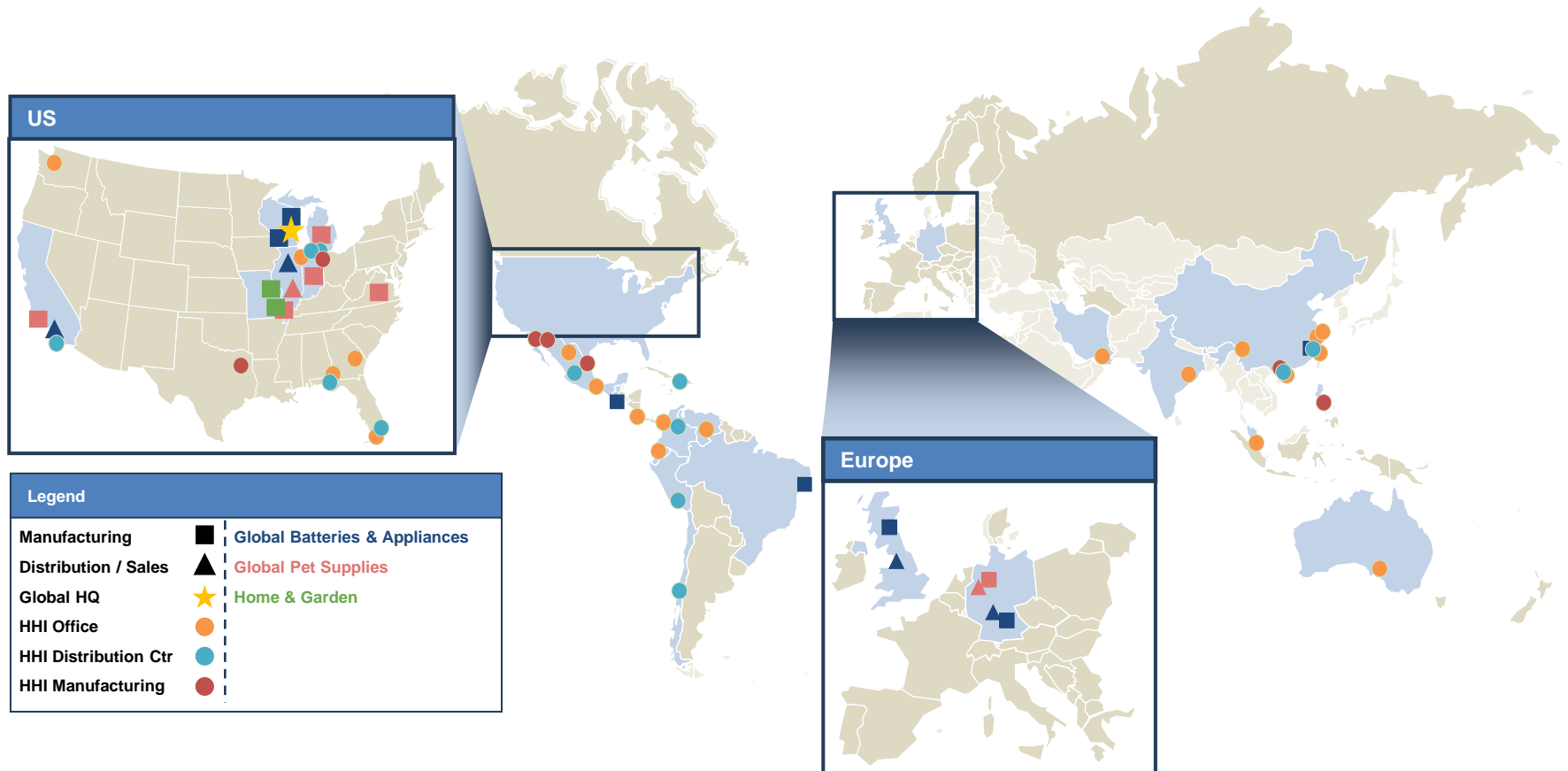

Note: Locations consist of sales, administrative and regional offices, warehouses, manufacturing and distribution centers (not all offices are reflected).

Evolution of Global Batteries

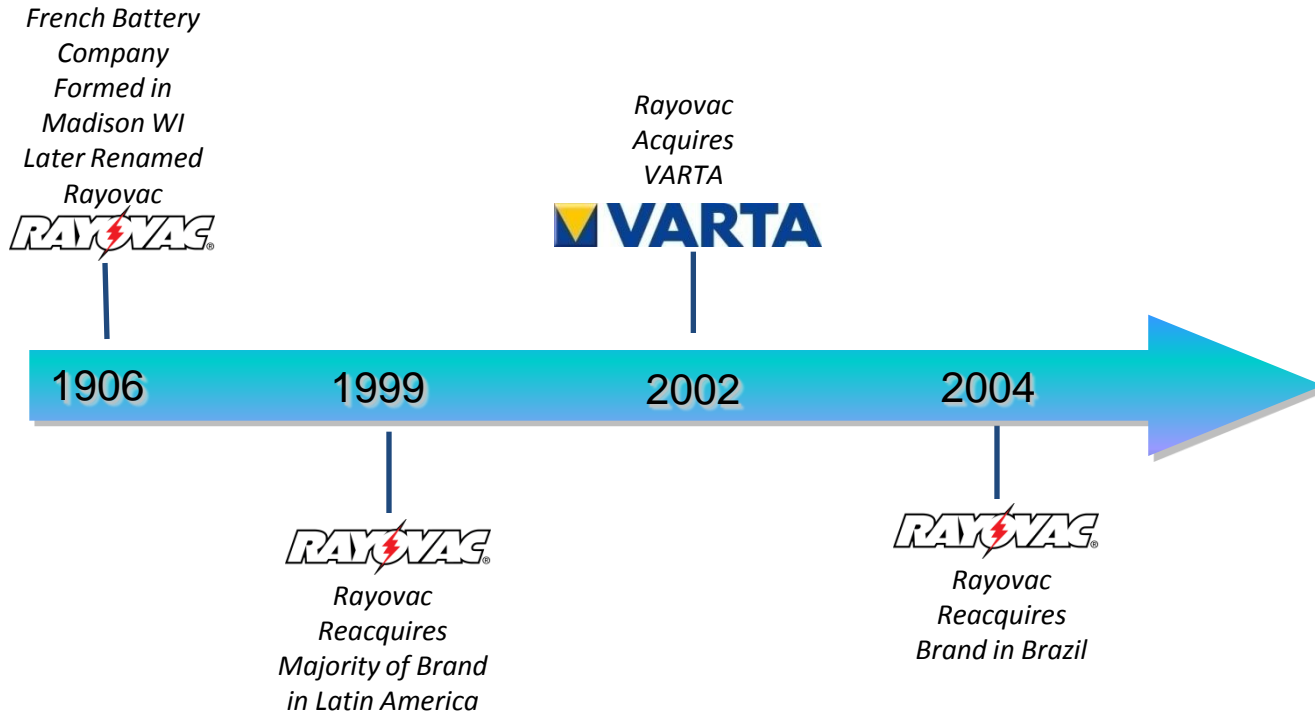

Batteries is an Attractive Segment for SPB Given Market Share Gains & Estimated Organic Growth (Alkaline at 3.5% per Year)

Global Battery Market: Revenue by Battery Type (World), 2010-2016

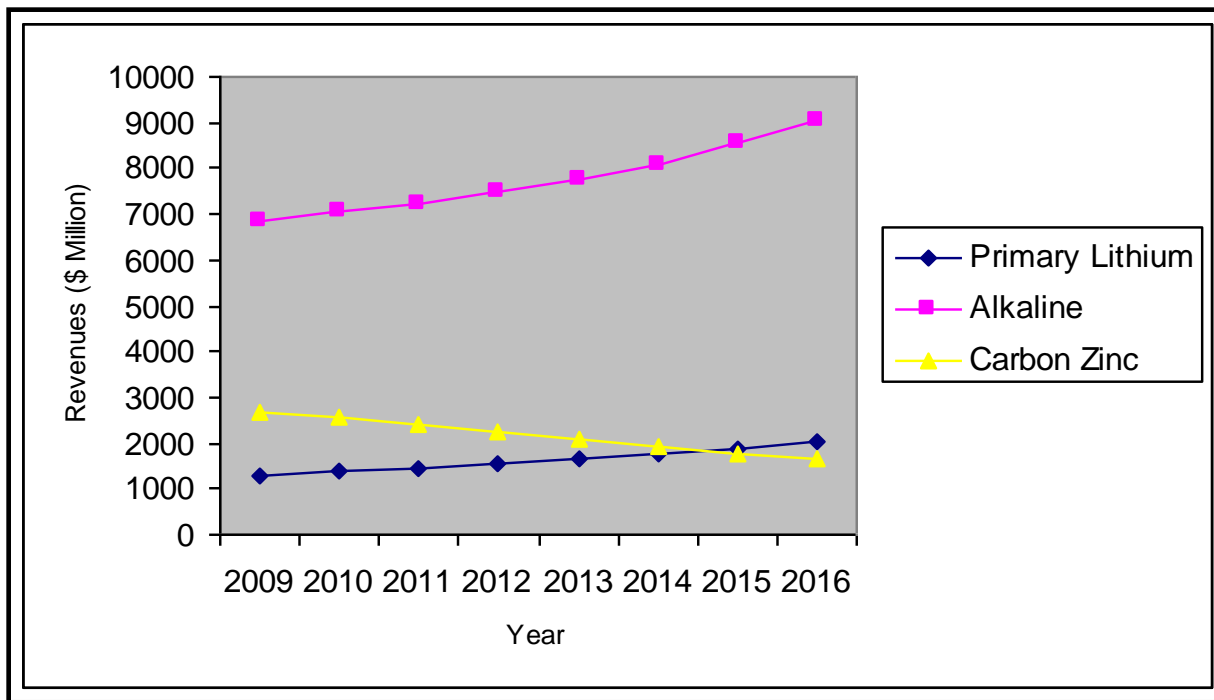





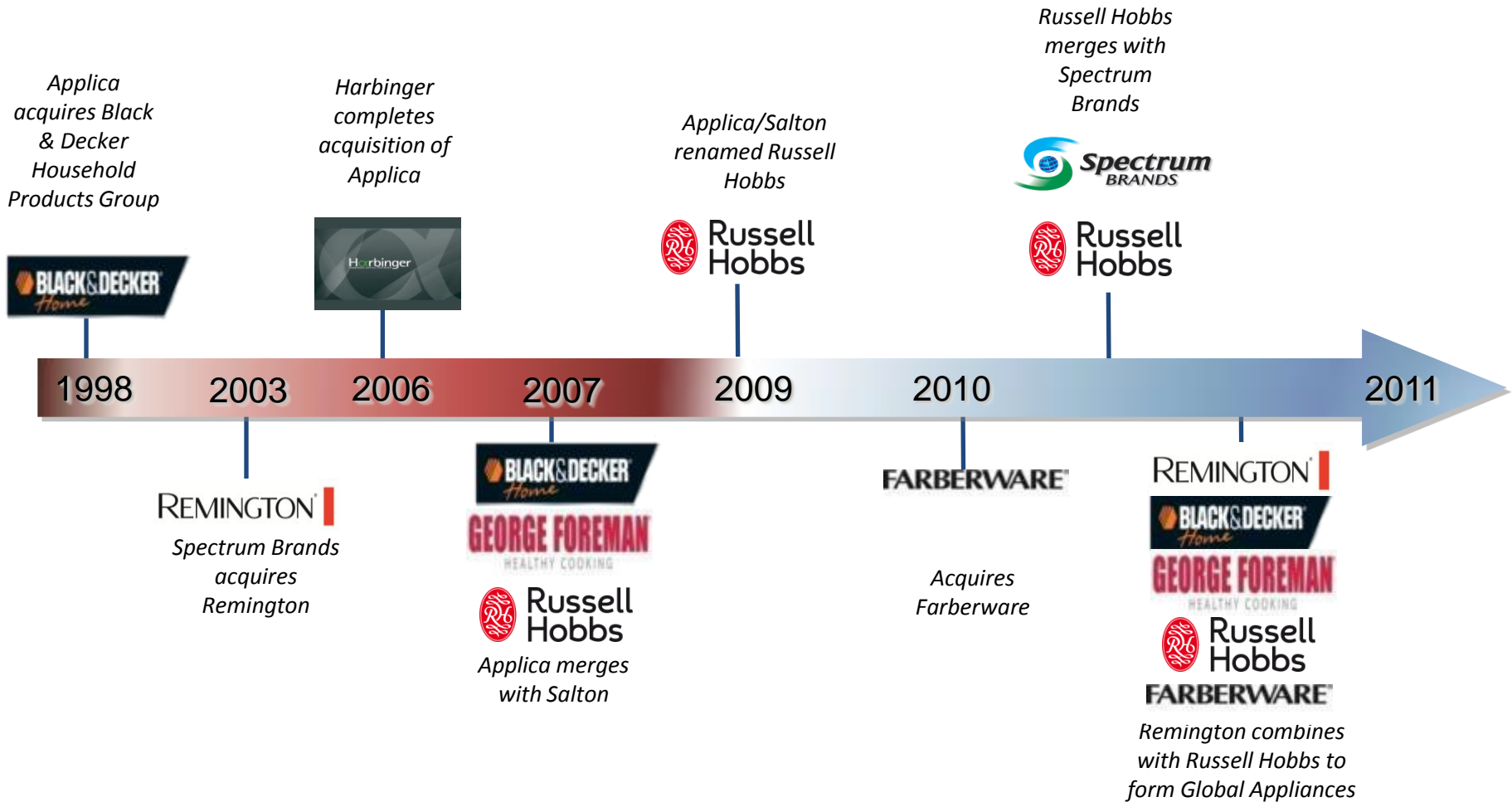

Source: Frost & Sullivan Analysis



Evolution of Global Appliances









Global Appliances – Diversified Product Line-up

Representative Brands	Kitchen Products	Home Products	Personal Care
Product Offerings	<p> Breadman FARBERWARE GEORGE FOREMAN Juiceman BLACK&DECKER <i>Home</i> Russell Hobbs toastmaster </p> <ul style="list-style-type: none"> ▪ Kettles ▪ Storage and organization products ▪ Food storages ▪ Grills ▪ Toaster ovens ▪ Toasters ▪ Blenders / mixers ▪ Can openers ▪ Coffee makers / grinders ▪ Electric knives ▪ Deep fryers ▪ Food choppers ▪ Food processors ▪ Juicers ▪ Hand mixers ▪ Rice cookers ▪ Steamers ▪ Bread makers ▪ Sandwich makers  	<p> BLACK&DECKER <i>Home</i> Russell Hobbs <i>windmere</i> </p> <ul style="list-style-type: none"> ▪ Hand-held irons ▪ Vacuum cleaners ▪ Air purifiers ▪ Clothes shavers ▪ Heaters  	<p> REMINGTON </p> <ul style="list-style-type: none"> ▪ Straighteners, stylers, curling irons ▪ Men's and women's electric shavers & epilators ▪ Men's and women's groomers ▪ Haircut kits ▪ Hand-held hair dryers ▪ Hair setters ▪ i-Light ▪ Women's hair accessories  

UPG: An Impressive Portfolio of Leading Brands









Aquatics

Brand	Product Categories
	7
	5
	3
	2
	2
	3

Companion Animal

Brand	Product Categories
	2
	7
	3
	4
	1
	3

Long-Standing Global Customer Relationships

Retailer	Length of Relationship	Category Manager/ Advisor Roles
	20 Years	Aquatics Small Animal / Domestic Bird Dog Containment
	> 15 Years	Aquatics Dog & Cat Health and Beauty Aids Rawhide Stain & Odor Control Products
	> 15 Years	Aquatics Dog & Cat Health and Beauty Aids Small Animal / Domestic Bird Stain & Odor Control Products
	> 10 Years	Dog & Cat Health and Beauty Aids Rawhide Small Animal / Domestic Bird Aquatics
	> 10 Years	Aquatics
	> 10 Years	Aquatics
	> 10 Years	Aquatics
	> 20 Years	Aquatics

UPG Historical Review: Acquisitions and Integration



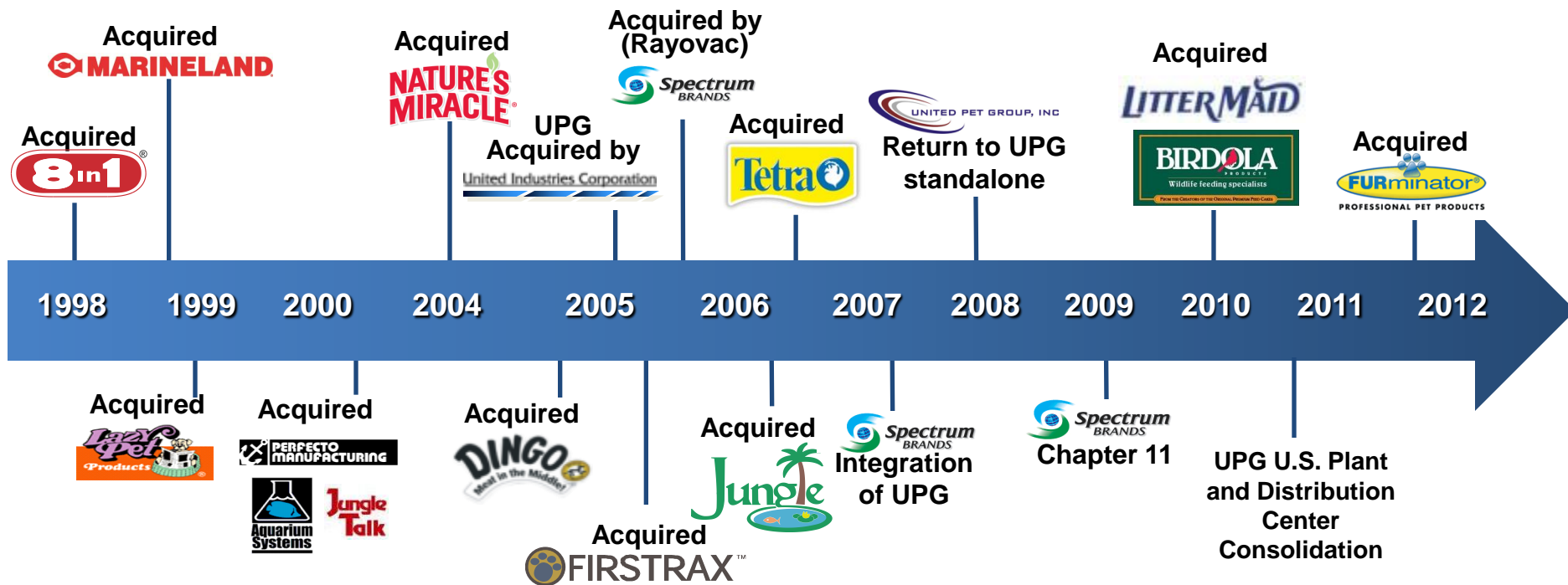



- United Pet Group (UPG) was formed in 1998 by TA Associates and between 1999-2006 successfully executed an acquisition/integration strategy within the U.S. pet supplies industry
- Acquired by Spectrum in 2005 with subsequent acquisitions of Tetra and Jungle
- Current opportunity: finalize the consolidation, restart acquisition activity and globalize companion animal segment



Acquisition: UPG is the Only Global Platform in the Industry

- Dedicated sales, marketing and operations teams in 3 primary geographies: North America, Europe, Pacific Rim
 - Represents 90% of the total pet supply market
- Competitors lack similar infrastructure
- Ideal to execute a global roll-up strategy

Comparative Global Infrastructure

	North America	Latin America	Europe	Japan
	✓	✓	✓	✓
	✓			
	✓	✓		
	✓		✓	
	✓		✓	
	✓			

Highly Recognized and Respected Value Brands

Controls



- Weed & Grass Killers
- Outdoor Insect Control



Household



- Ant, Roach and Wasp Killers
- Indoor Insect Control



Repellents



- Personal and Area Mosquito Repellents
- Yard Treatment Products



Rodenticide & Other



- Mouse / Rat Baits and Traps
- Plant Food



Recent Acquisitions Drive Top-Line and Bottom-Line

Black Flag/TAT Brands Acquisition – November 2011

- Black Flag/TAT produces and distributes a line of insecticide products, including liquids, aerosols, baits and traps that control ants, spiders, wasps, bedbugs, fleas and other insects, as well as roach, fly and yellow jacket products for motels
- Accretive transaction strengthens Home & Garden's household insecticide portfolio and increases market share of the US consumer pest control market
 - Black Flag/TAT enhance Spectrum's capabilities to serve consumer marketplace while expanding household insecticide presence in several less developed retail channels
 - Black Flag is one of the oldest brands in the US (dates to 1833) with extraordinary consumer recognition
 - Opportunity for meaningful manufacturing and distribution synergies



FURminator Acquisition – December 2011

- FURminator is a leading global provider of branded, patented dog and cat grooming products with annual revenue of approximately \$40 million
- Accretive transaction provides Spectrum with a leadership position in global dog and cat grooming category
 - Management expects the global dog/cat grooming category to grow a 3%–4% per year
- \$140 million purchase price (represents approximately 6-7x EBITDA multiple after achieving significant synergies in first 12 to 18 months)
- Acquisition helps provide additional balance in Spectrum's Global Pet Supplies business which includes both aquatics and companion animals



Financial Snapshot

Pro forma net sales

(\$ in millions)

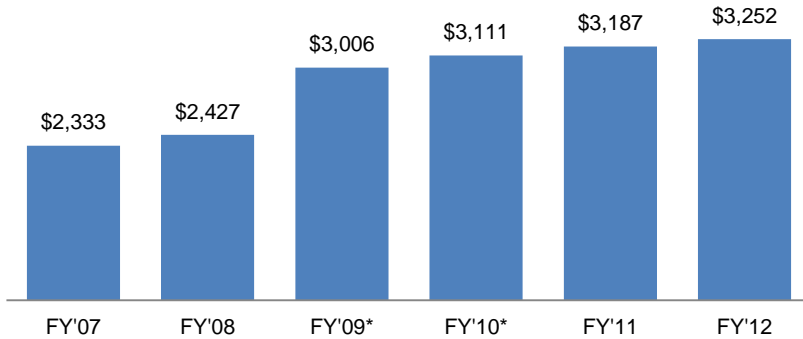

Adjusted EBITDA

(\$ in millions)

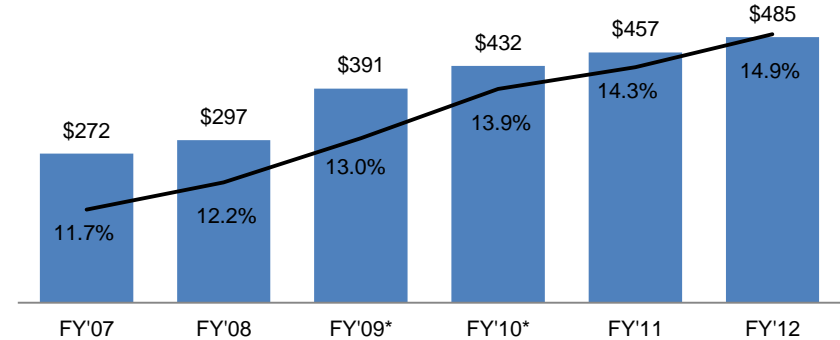

Capital expenditures

(\$ in millions)

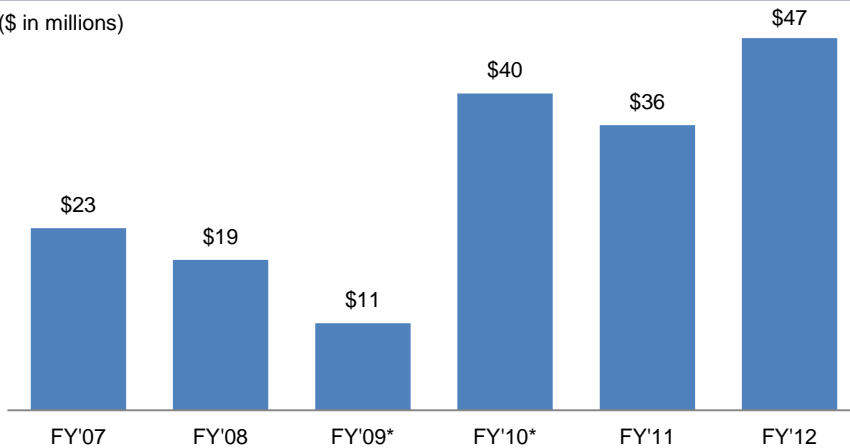

Adjusted EBITDA less capital expenditures

(\$ in millions)

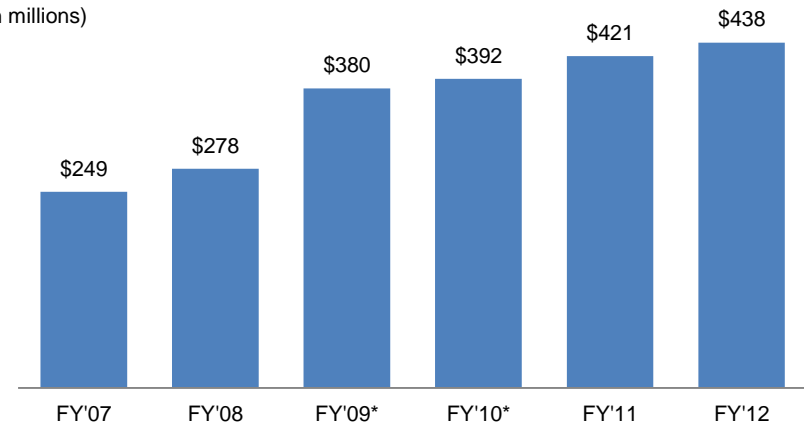

Proven track record of top-line growth and improving profitability

* Reflects pro forma as if Russell Hobbs merger completed at beginning of respective period.

Summary Consolidated Financial Information

(\$ in millions)	Predecessor Co.		Combined ¹		Successor Company					
	Fiscal Year Ended September 30,									
	2008	2009	2010	2011	2012					
Key Metrics:										
Pro forma net sales	\$	2,427	\$	3,006	\$	3,111	\$	3,187	\$	3,252
Adjusted EBITDA		297		391		432		457		485
Other Data:										
Capital expenditures	\$	19	\$	11	\$	40	\$	36	\$	47
Depreciation and amortization		85		67		117		135		134
Cash Flow Data:										
Net cash provided by (used in):										
Operating activities	\$	(10)	\$	77	\$	57	\$	227	\$	255
Investing activities		(6)		(20)		(43)		(46)		(231)
Financing activities		52		(65)		66		(211)		(7)
Balance Sheet Data: ²										
Cash and cash equivalents	\$	105	\$	98	\$	171	\$	142	\$	158
Working capital		372		324		537		441		451
Total assets		2,248		3,021		3,874		3,627		3,752
Total debt (GAAP)		2,523		1,585		1,744		1,552		1,669
Total debt (Gross) ³		2,523		1,660		1,770		1,565		1,665

(1) Combined twelve months ended 09/30/2009 refers to the sum of the predecessor period of 10/01/2008 to 08/30/2009 and the successor period of 08/30/2009 to 09/30/2009.

(2) Balance sheet dates prior to the Merger with Russell Hobbs on 6/16/2010 have not been restated to reflect the combined company.

(3) Calculated as total gross debt /adjusted EBITDA. Gross debt is stated prior to OID and other discounts.

Supplemental Financial Information

(\$ in millions)	Predecessor Co.	Combined ¹	Successor Company		
	Fiscal Year Ended September 30,				
	2008	2009	2010	2011	2012
Net Sales					
Net sales, as reported	\$ 2,427	\$ 2,231	\$ 2,567	\$ 3,187	\$ 3,252
Pre-acquisition sales ²	-	775	544	-	-
Pro forma net sales	\$ 2,427	\$ 3,006	\$ 3,111	\$ 3,187	\$ 3,252

- (1) Combined 12 months ended 09/30/2009 refers to the sum of the predecessor period of 10/01/2008 to 08/30/2009 and the successor period of 08/30/2009 to 09/30/2009.
(2) Reflects Russell Hobbs net sales as if the merger was consummated 10/01/2008.

Reconciliation of Adjusted EBITDA

(\$ in millions)	Predecessor Co.		Combined ¹		Successor Company		
	Fiscal Year Ended September 30,						
	2008	2009	2010	2011	2012		
Net (Loss) Income	\$ (932)	\$ 943	\$ (190)	\$ (75)	\$ 49		
Interest expense ²	229	190	277	208	192		
Income tax (benefit) expense	(10)	74	63	92	60		
Depreciation and amortization ³	85	67	117	135	134		
EBITDA	\$ (627)	\$ 1,274	\$ 268	\$ 360	\$ 435		
Pre-acquisition earnings ⁴	\$ -	\$ 81	\$ 66	\$ -	\$ -		
Goodwill and intangibles impairment	861	34	-	32	-		
Restructuring and related charges	39	46	24	29	19		
Acquisition and integration related charges	-	-	38	37	31		
Loss from discontinued operations, net of tax	26	86	3	-	-		
Brazilian IPI credit ⁵	(12)	(6)	(5)	-	-		
Reorganization items, net	-	(1,139)	4	-	-		
Fresh-start inventory fair value adjustments	-	16	35	-	-		
Other fair value adjustments	-	2	3	-	-		
Accelerated depreciation and amortization ⁶	-	(4)	(3)	(1)	-		
Transaction costs	9	-	-	-	-		
Adjusted EBITDA	\$ 297	\$ 391	\$ 432	\$ 457	\$ 485		

- (1) Combined 12 months ended 09/30/2009 refers to the sum of the predecessor period of 10/01/2008 to 08/30/2009 and the successor period of 08/30/2009 to 09/30/2009.
- (2) During FY 2011, we recorded accelerated amortization of unamortized discounts and unamortized debt issuance costs totaling \$61.4 million as an adjustment to increase interest expense.
- (3) Excludes amortization of debt issuance costs.
- (4) Reflects pro forma earnings of Russell Hobbs as if the Merger was consummated on October 1, 2008.
- (5) Adjustment reflects expiring taxes and related estimated penalties, associated with our provision for presumed credits applied to the Brazilian excise tax on manufactured products, for which the examination period expired.
- (6) Adjustment reflects accelerated amortization and/or depreciation associated with restructuring initiatives. As this amount is included within restructuring and related charges, the adjustment negates the impact of reflecting the add back of depreciation and/or amortization twice.

Reconciliation of Adjusted EBITDA by Segment

(\$ in millions)	FY 2012					
	Global Batteries & Appliances	Global Pet Supplies	Home & Garden Business	Corporate	Unallocated Items ¹	Consolidated Spectrum
Net (Loss) Income, as adjusted	\$ 221	\$ 70	\$ 71	\$ (61)	\$ (252)	\$ 49
Interest expense	-	-	-	-	192	192
Income tax expense	-	-	-	-	60	60
Depreciation and amortization ²	64	28	13	29	-	134
EBITDA	\$ 285	\$ 98	\$ 84	\$ (32)	-	\$ 435
Restructuring and related charges	\$ 7	\$ 10	\$ 1	\$ 1	-	\$ 19
Acquisition and integration related charges	15	5	2	9	-	31
Adjusted EBITDA	\$ 307	\$ 113	\$ 87	\$ (22)	-	\$ 485

(1) It is our policy to record income tax expense and interest expense on a consolidated basis. Accordingly, such amounts are not reflected in the operating results of the operating segments.

(2) Excludes amortization of debt issuance costs.

Table 1
SPECTRUM BRANDS HOLDINGS, INC.
Condensed Consolidated Statements of Operations
For the three and twelve months ended September 30, 2012 and September 30, 2011
(Unaudited)
(In millions, except per share amounts)

	Three Months Ended September 30,			Twelve Months Ended September 30,		
	F2012	F2011	INC(DEC) %	F2012	F2011	INC(DEC) %
Net sales	\$ 832.6	\$ 827.3	0.6%	\$ 3,252.4	\$ 3,186.9	2.1%
Cost of goods sold	551.1	543.9		2,126.9	2,050.2	
Restructuring and related charges	1.5	2.9		9.8	7.8	
Gross profit	<u>280.0</u>	<u>280.5</u>	-0.2%	<u>1,115.7</u>	<u>1,128.9</u>	-1.2%
Selling	129.7	132.8		521.2	536.5	
General and administrative	60.7	62.0		218.8	241.7	
Research and development	9.3	7.3		33.1	32.9	
Acquisition and integration related charges	10.4	5.1		31.1	36.6	
Restructuring and related charges	2.3	8.0		9.7	20.8	
Intangibles impairment	-	32.5		-	32.5	
Total operating expenses	<u>212.4</u>	<u>247.7</u>		<u>813.9</u>	<u>901.0</u>	
Operating income	67.6	32.8		301.8	227.9	
Interest expense	41.8	42.4		191.9	208.3	
Other (income) expense, net	<u>(1.3)</u>	<u>1.1</u>		<u>0.9</u>	<u>2.5</u>	
Income (loss) from continuing operations before income tax expense	27.1	(10.7)		109.0	17.1	
Income tax expense	<u>21.6</u>	<u>23.1</u>		<u>60.4</u>	<u>92.3</u>	
Net income (loss)	<u>\$ 5.5</u>	<u>\$ (33.8)</u>		<u>\$ 48.6</u>	<u>\$ (75.2)</u>	
Average shares outstanding (a)	51.4	51.9		51.6	51.1	
Basic income (loss) per share	\$ 0.11	\$ (0.65)		\$ 0.94	\$ (1.47)	
Average shares and common stock equivalents outstanding (a) (b)	53.1	51.9		53.3	51.1	
Diluted income (loss) per share	\$ 0.10	\$ (0.65)		\$ 0.91	\$ (1.47)	

(a) Per share figures calculated prior to rounding.

(b) For the three and twelve months ended September 30, 2011, we have not assumed the exercise of common stock equivalents as the impact would be antidilutive.

Table 2
SPECTRUM BRANDS HOLDINGS, INC.
Supplemental Financial Data

For the three and twelve months ended September 30, 2012 and September 30, 2011
(Unaudited)
(\$ in millions)

<u>Supplemental Financial Data</u>	<u>F2012</u>	<u>F2011</u>		
Cash and cash equivalents	\$ 158.0	\$ 142.4		
Trade receivables, net	\$ 335.3	\$ 356.6		
Days Sales Outstanding (a)	33	33		
Inventories	\$ 452.6	\$ 434.6		
Inventory Turnover (b)	4.1	3.8		
Total Debt	\$ 1,669.3	\$ 1,551.6		
	<u>Three Months Ended September 30,</u>		<u>Twelve Months Ended September 30,</u>	
<u>Supplemental Cash Flow Data</u>	<u>F2012</u>	<u>F2011</u>	<u>F2012</u>	<u>F2011</u>
Depreciation and amortization, excluding amortization of debt issuance costs	\$ 42.7	\$ 34.5	\$ 133.8	\$ 135.1
Capital expenditures	\$ 13.7	\$ 8.7	\$ 46.8	\$ 36.2
	<u>Three Months Ended September 30,</u>		<u>Twelve Months Ended September 30,</u>	
<u>Supplemental Segment Sales & Profitability</u>	<u>F2012</u>	<u>F2011</u>	<u>F2012</u>	<u>F2011</u>
<u>Net Sales</u>				
Global Batteries & Appliances	\$ 580.0	\$ 592.9	\$ 2,249.9	\$ 2,254.1
Global Pet Supplies	166.5	153.8	615.5	578.9
Home and Garden	86.1	80.6	387.0	353.9
Total net sales	<u>\$ 832.6</u>	<u>\$ 827.3</u>	<u>\$ 3,252.4</u>	<u>\$ 3,186.9</u>
<u>Segment Profit</u>				
Global Batteries & Appliances	\$ 58.7	\$ 58.4	\$ 244.4	\$ 238.9
Global Pet Supplies	28.1	21.7	85.9	75.6
Home and Garden	13.1	14.2	73.6	65.2
Total segment profit	99.9	94.3	403.9	379.7
Corporate	18.1	13.0	51.5	54.1
Restructuring and related charges	3.8	10.9	19.5	28.6
Acquisition and integration related charges	10.4	5.1	31.1	36.6
Intangibles impairment	-	32.5	-	32.5
Interest expense	41.8	42.4	191.9	208.3
Other (income) expense, net	<u>(1.3)</u>	<u>1.1</u>	<u>0.9</u>	<u>2.5</u>
Income (loss) from continuing operations before income tax expense	<u>\$ 27.1</u>	<u>\$ (10.7)</u>	<u>\$ 109.0</u>	<u>\$ 17.1</u>

(a) Reflects actual days sales outstanding at end of period.

(b) Reflects cost of sales (excluding restructuring and related charges) during the last twelve months divided by average inventory as of the end of the period.

Table 3
SPECTRUM BRANDS HOLDINGS, INC.
Reconciliation of GAAP Diluted Income (Loss) Per Share to Adjusted Diluted Income Per Share
For the three and twelve months ended September 30, 2012 and September 30, 2011
(Unaudited)

	THREE MONTHS		TWELVE MONTHS	
	F2012	F2011	F2012	F2011
Diluted income (loss) per share, as reported	\$ 0.10	\$ (0.65)	\$ 0.91	\$ (1.47)
Adjustments, net of tax:				
Acquisition and integration related charges	0.13 (a)	0.06 (b)	0.38 (a)	0.47 (b)
Restructuring and related charges	0.04 (c)	0.14 (d)	0.24 (c)	0.36 (e)
Intangible asset impairment	-	0.41 (f)	-	0.41 (f)
Debt refinancing costs	-	-	0.33 (g)	0.37 (h)
Income taxes	0.23 (i)	0.51 (j)	0.42 (i)	1.69 (j)
	0.40	1.12	1.37	3.30
Diluted income per share, as adjusted	\$ 0.50	\$ 0.47	\$ 2.28	\$ 1.83

(a) For the three and twelve months ended September 30, 2012, reflects \$6.8 million, net of tax, and \$20.2 million, net of tax, respectively, of acquisition and integration related charges. During the three months ended September 30, 2012, reflects the following: (i) \$2.5 million related to the Merger with Russell Hobbs; (ii) \$1.2 million related to the acquisition of FURminator; (iii) \$1.0 related to the acquisition of Black Flag; and (iv) \$2.1 million related to other acquisition activity. During the twelve months ended September 30, 2012, reflects the following: (i) \$10.1 million related to the Merger with Russell Hobbs; (ii) \$5.3 million related to the acquisition of FURminator; (iii) \$2.2 related to the acquisition of Black Flag; and (iv) \$2.6 million related to other acquisition activity.

(b) For the three and twelve months ended September 30, 2011, reflects \$3.3 million, net of tax, and \$23.8 million, net of tax, respectively, of acquisition and integration related charges primarily in connection with the Merger with Russell Hobbs. These charges were primarily costs incurred to integrate the businesses.

(c) For the three and twelve months ended September 30, 2012, reflects \$2.4 million, net of tax, and \$12.7 million, net of tax, respectively, of restructuring and related charges primarily related to the Global Cost Reduction Initiatives announced in Fiscal 2009.

(d) For the three months ended September 30, 2011, reflects \$7.1 million, net of tax, of restructuring and related charges related to the Global Cost Reduction Initiatives announced in Fiscal 2009.

(e) For the twelve months ended September 30, 2011, reflects \$18.6 million, net of tax, of restructuring and related charges as follows: (i) \$16.6 million for the Global Cost Reduction Initiatives announced in Fiscal 2009 and (ii) \$2.0 million for the Global Realignment Initiatives announced in Fiscal 2007.

(f) For the three and twelve months ended September 30, 2011, reflects an impairment charge of \$21.1 million, net of tax, related to trade names as follows: (i) \$15.1 million related to Global Batteries & Appliances; (ii) \$5.6 million related to Global Pet Supplies; and (iii) \$0.4 million related to the Home and Garden Business. The impairment evaluation was done in accordance with ASC 350, "Intangibles-Goodwill and Other."

(g) For the twelve months ended September 30, 2012, reflects \$17.9 million, net of tax, related to the write off of unamortized debt issuance costs in connection with the replacement of the Company's 12% Notes during the fiscal quarter ended April 1, 2012.

(h) For the twelve months ended September 30, 2011, reflects \$19.1 million, net of tax, related to the write off of unamortized debt financing costs and original issue discount in connection with the refinancing of the Company's Term Loan during Company's fiscal quarter ended April 3, 2011.

(i) For the three and twelve months ended September 30, 2012, reflects adjustments to income tax expense of \$12.1 million and \$22.3 million, respectively, to exclude the impact of the valuation allowance against deferred taxes and other tax related items in order to reflect a normalized effective tax rate.

(j) For the three and twelve months ended September 30, 2011, reflects adjustments to income tax expense of \$26.9 million and \$86.3 million, respectively, to exclude the impact of the valuation allowance against deferred taxes and other tax related items in order to reflect a normalized effective tax rate.

Table 4
SPECTRUM BRANDS HOLDINGS, INC.
Reconciliation of GAAP Net Income (Loss) to Adjusted EBITDA
for the three months ended September 30, 2012
(Unaudited)
(\$ millions)

	<u>Global Batteries & Appliances</u>	<u>Global Pet Supplies</u>	<u>Home & Garden</u>	<u>Corporate</u>	<u>Unallocated Items (a)</u>	<u>Consolidated Spectrum Brands Holdings, Inc.</u>
Net income (loss), as adjusted (a)	\$ 55.2	\$ 23.1	\$ 11.9	\$ (21.2)	\$ (63.4)	\$ 5.5
Income tax benefit	-	-	-	-	21.6	21.6
Interest expense	-	-	-	-	41.8	41.8
Acquisition and integration related charges	3.7	1.8	1.5	3.4	-	10.4
Restructuring and related charges	0.6	3.2	(0.3)	0.1	-	3.8
Adjusted EBIT	\$ 59.5	\$ 28.1	\$ 13.1	\$ (17.7)	\$ -	\$ 83.1
Depreciation and amortization (b)	17.6	7.5	4.2	13.4	-	42.7
Adjusted EBITDA	\$ 77.1	\$ 35.7	\$ 17.3	\$ (4.3)	\$ -	\$ 125.8

Note: Amounts calculated prior to rounding

(a) It is the Company's policy to record Income tax expense and interest expense on a consolidated basis. Accordingly, such amounts are not reflected in the results of the operating segments and presented within Unallocated Items.

(b) Included within depreciation and amortization is amortization of unearned restricted stock compensation.

Table 4
SPECTRUM BRANDS HOLDINGS, INC.
Reconciliation of GAAP Net Income (Loss) to Adjusted EBITDA
for the twelve months ended September 30, 2012
(Unaudited)
(\$ millions)

	<u>Global Batteries & Appliances</u>	<u>Global Pet Supplies</u>	<u>Home & Garden</u>	<u>Corporate</u>	<u>Unallocated Items (a)</u>	<u>Consolidated Spectrum Brands Holdings, Inc.</u>
Net income (loss), as adjusted (a)	\$ 221.6	\$ 69.8	\$ 70.6	\$ (61.1)	\$ (252.3)	\$ 48.6
Income tax expense	-	-	-	-	60.4	60.4
Interest expense	-	-	-	-	191.9	191.9
Acquisition and integration related charges	14.9	5.4	2.1	8.6	-	31.1
Restructuring and related charges	7.6	10.1	0.9	1.0	-	19.6
Adjusted EBIT	\$ 244.1	\$ 85.3	\$ 73.6	\$ (51.5)	\$ -	\$ 351.5
Depreciation and amortization (b)	63.6	27.7	13.3	29.2	-	133.8
Adjusted EBITDA	\$ 307.7	\$ 113.1	\$ 86.9	\$ (22.4)	\$ -	\$ 485.3

Note: Amounts calculated prior to rounding

(a) It is the Company's policy to record Income tax expense and interest expense on a consolidated basis. Accordingly, such amounts are not reflected in the results of the operating segments and presented within Unallocated Items.

(b) Included within depreciation and amortization is amortization of unearned restricted stock compensation.

Table 4
SPECTRUM BRANDS HOLDINGS, INC.
Reconciliation of GAAP Net Income (Loss) to Adjusted EBITDA
for the three months ended September 30, 2011
(Unaudited)
(\$ millions)

	<u>Global Batteries & Appliances</u>	<u>Global Pet Supplies</u>	<u>Home & Garden</u>	<u>Corporate</u>	<u>Unallocated Items (a)</u>	<u>Consolidated Spectrum Brands Holdings, Inc.</u>
Net income (loss), as adjusted (a)	\$ 24.8	\$ 6.3	\$ 12.9	\$ (12.2)	\$ (65.5)	\$ (33.8)
Income tax expense	-	-	-	-	23.1	23.1
Interest expense	-	-	-	-	42.4	42.4
Restructuring and related charges	4.6	6.8	0.6	(1.3)	-	10.9
Acquisition and integration related charges	6.7	-	-	(1.6)	-	5.1
Intangible asset impairment	23.2	8.6	0.7	-	-	32.5
Adjusted EBIT	\$ 59.3	\$ 21.7	\$ 14.2	\$ (15.1)	\$ -	\$ 80.0
Depreciation and amortization (b)	17.2	6.7	3.1	7.6	-	34.5
EBITDA	<u>\$ 76.5</u>	<u>\$ 28.3</u>	<u>\$ 17.3</u>	<u>\$ (7.5)</u>	<u>\$ -</u>	<u>\$ 114.5</u>

Note: Amounts calculated prior to rounding

(a) It is the Company's policy to record Income tax expense and interest expense on a consolidated basis. Accordingly, such amounts are not reflected in the results of the operating segments and presented within Unallocated Items.

(b) Included within depreciation and amortization is amortization of unearned restricted stock compensation.

Table 4
SPECTRUM BRANDS HOLDINGS, INC.
Reconciliation of GAAP Net Income (Loss) to Adjusted EBITDA
for the twelve months ended September 30, 2011
(Unaudited)
(\$ millions)

	<u>Global Batteries & Appliances</u>	<u>Global Pet Supplies</u>	<u>Home & Garden</u>	<u>Corporate</u>	<u>Unallocated Items (a)</u>	<u>Consolidated Spectrum Brands Holdings, Inc.</u>
Net income (loss), as adjusted (a)	\$ 179.6	\$ 49.1	\$ 61.8	\$ (65.2)	\$ (300.6)	\$ (75.2)
Income tax expense	-	-	-	-	92.3	92.3
Interest expense	-	-	-	-	184.0	184.0
Write-off unamortized discounts and financing fees (b)	-	-	-	-	24.3	24.3
Restructuring and related charges	6.1	16.7	2.7	3.1	-	28.6
Acquisition and integration related charges	30.9	0.4	-	5.3	-	36.6
Intangible asset impairment	23.2	8.6	0.7	-	-	32.5
Add back accelerated depreciation (c)	(1.0)	-	-	-	-	(1.0)
Adjusted EBIT	\$ 238.8	\$ 74.8	\$ 65.2	\$ (56.8)	\$ -	\$ 322.0
Depreciation and amortization (d)	68.1	24.3	12.4	30.4	-	135.1
EBITDA	<u>\$ 306.9</u>	<u>\$ 99.1</u>	<u>\$ 77.6</u>	<u>\$ (26.4)</u>	<u>\$ -</u>	<u>\$ 457.1</u>

Note: Amounts calculated prior to rounding

(a) It is the Company's policy to record Income tax expense and interest expense on a consolidated basis. Accordingly, such amounts are not reflected in the results of the operating segments and presented within Unallocated Items.

(b) Adjustment reflects the write off of unamortized deferred financing fees and discounts associated with the refinancing of the Company's Term Loan facility.

(c) Adjustment reflects accelerated depreciation associated with certain restructuring initiatives. Inasmuch as this amount is included within Restructuring and related charges, this adjustment negates the impact of reflecting the add back of depreciation.

(d) Included within depreciation and amortization is amortization of unearned restricted stock compensation.

Table 5
SPECTRUM BRANDS HOLDINGS, INC.
Reconciliation of Cash Flow from Operating Activities to Free Cash Flow
for the twelve months ended September 30, 2012

(Unaudited)
(\$ millions)

Net Cash provided from Operating Activities		\$255
Purchases of property, plant and equipment		(47)
Free Cash Flow		\$208

Table 6
SPECTRUM BRANDS HOLDINGS, INC.
Reconciliation of Forecasted Cash Flow from Operating Activities to Forecasted Free Cash Flow
for the twelve months ending September 30, 2013

(Unaudited)
(\$ millions)

Forecasted:

Net Cash provided from Operating Activities		\$ 310 - 320
Purchases of property, plant and equipment		(70) - (80)
Free Cash Flow		\$240